

**←INSIZE→**  
www.insize.com

←INSIZE→



**ISV-RV**  
**SIDE VIEW VIDEOSCOPE (RIGID)**

**←INSIZE→**

**Attention**

1.1 The front of the lens can not hit.

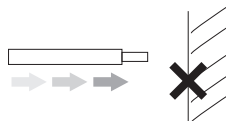

1.2 The waterproof probe of lens is IP57, while the depth of the lens in water should be within 1m and no more than 30 minutes. And the depth of the lens in oil should be within 6cm and no more than 10 minutes.

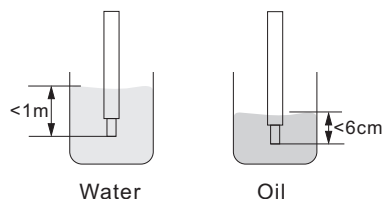

1.3 The lens and cable are not covered by warranty. They may be damaged due to improper operation and can not be repaired.

**Structure**



- a -lens
- b -adjustable LED illumination
- c -connection cable
- d -handle

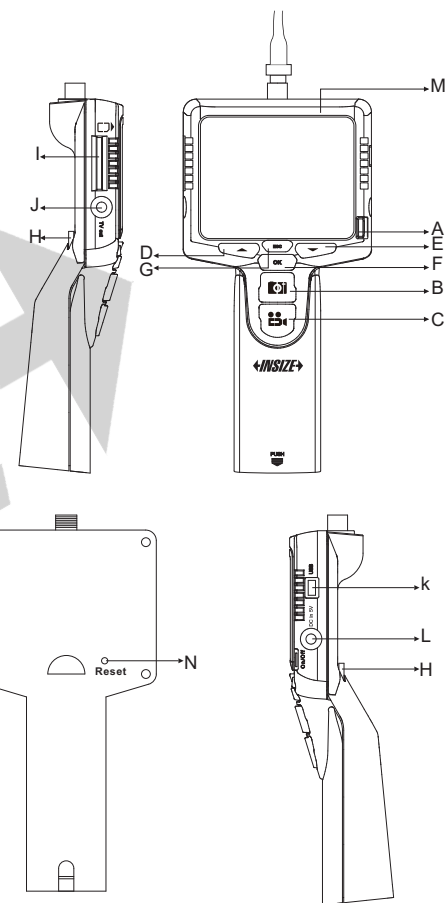

- A **On/Off** -power on/off
- B -take photo
- C -take video
- D -up
- E -down
- F **OK** -menu
- G **ESC** -return
- H **LED** brightness adjustment
- I **SD** card
- J **TV** port
- K **USB** port
- L **DC** in 5V
- M **3.5"** LCD
- N **reset**

**Operation**

2.1 Choose the right connection cable according to the viewing workpiece. This product is supplied with a rigid 350mm long and 5.5m diameter cable, and if need to change to other types of connection cables, please loosen the nut anticlockwise and remove the cable (see below picture).

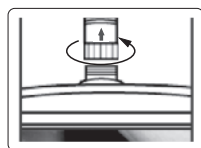

remove the cable

When mounting the cable, take attention of the place of the locating slot (see below picture), then tighten the nut.

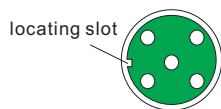

locating slot

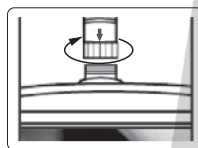

mount the cable

2.2 Press the “on/off” 3-5 seconds to turn on, and the screen will display about 5 seconds.

2.3 Move the lens to the viewing workpiece and adjust the distance between 4.5-5.5mm (focus distance), and the rate would be larger if the distance is much smaller during this range, and the biggest magnification is about 28X. Adjust the LED brightness to make the view more clearly.

Attention: It is common the lens burning hot when LED light up for a long time. The lens can also put into water or oil, and the waterproof probe is IP57.

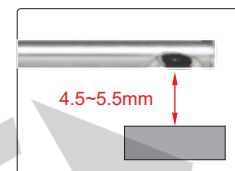

focus distance: 4.5~5.5mm

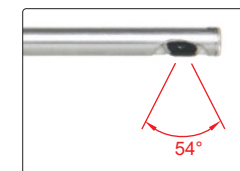

angle of view: 54°

The angle of side view is 54°, and to observe internal wall of holes, the minimum diameter is Ø10mm.

2.4 If display low battery in the right corner, please charge or replace the lithium battery.

Charge:  
Connect the AC/DC adapter to the DC in port of main unit, and the input voltage is 110-220V. The “” in the right corner would blink when charging (see below picture).

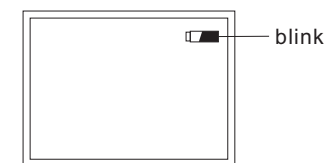

blink

When display “” and the battery do not change means the battery is full charged (see below picture).

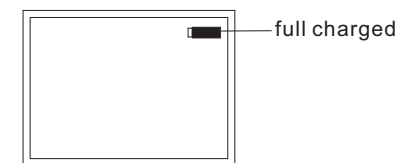

full charged

Replace the lithium battery:  
Press the white button, remove the battery cup and take out the used battery.

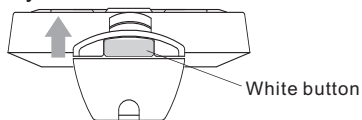

Before mounting the new battery, please lookover the battery carefully and the electrode on the battery “+ T -” need to keep pace with the electrode on the main unit.

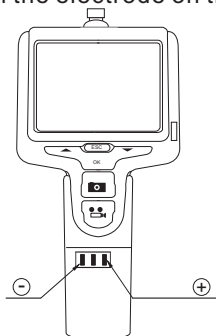

2.5 Press “take photo” button to take photos and press “take video” button once to start to take videos and press it again to finish taking videos.

2.6 Press “ESC” button, the screen will display the latest photo or video, then press “up” and “down” to overlook all the photos or videos in the SD card.

2.7 Connect the main unit to TV with TV cable, and the picture will display on the TV directly (Attention: the file format need to change to “ PAL/NSTC ” in correspondence with TV), and the picture would display on the main unit when take off form TV.

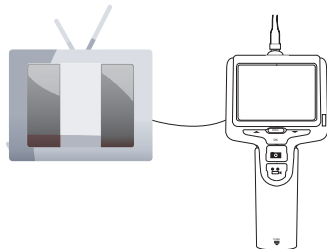

2.8 Connect the main unit to the computer with USB cable to copy the pictures or videos. Or take off the 2G SD card (press the SD card, it will automatically pop up for you), so you can also copy the pictures or videos with a card reader. Please take attention of the direction of the SD card when mounting, and the file format of picture is JPG, ASF for videos.

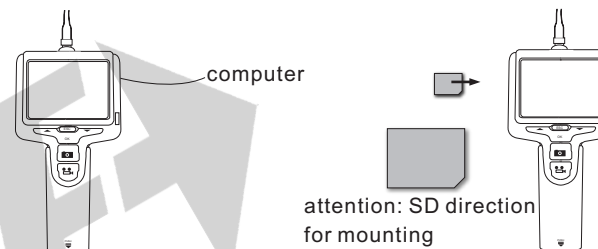

2.9 It will affect the observation when the lens get dusty after long used. Just clean the lens or reflector carefully with a clean bar dipping a small mount of alcohol.

**Function**

3.1 Three operation modes:

- Observational mode: display current view
- Overlook mode: overlook all pictures or videos in SD card
- Menu mode: set all function

3.2 Functions of buttons under different operation modes:

Buttons	Observational mode	Overlook mode	Menu mode
▲ ▼		select pictures	select up and down
OK	enter menu mode	delete pictures or videos	confirm selecting
ESC	enter overlook mode	enter observational mode	enter observational mode
📷	take photo	return previous mode	Display technology maintenance information
🎥	take or stop video	start or stop reading videos	return previous mode

**Menu**

Press "OK" under observational mode to enter menu.

- Video output
- Video format
- Date/Time setup
- language
- Delete all
- Auto power off
- Mirror mode

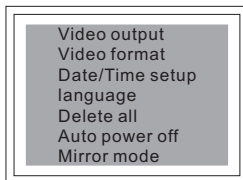

**4.1 Video format**

Setup TV format: NTSC/PAL, select one format then set the value of BRIGHTNESS, CONTRAST, HUE, SATURATION. When select "DEFAULT" to reset options to default. Press "up" or "down" to select one then press "OK", setup value by pressing "up" or "down", and just press "OK" when finish selecting.

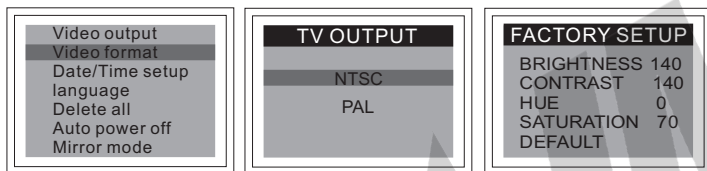

**4.2 Date/Time setup**

Select "Date/Time setup", press "up" and "down" to choose Year/Month/Date/Hour/Minute/Second, press "take photo" to increase the value, press "take video" to reduce the value.

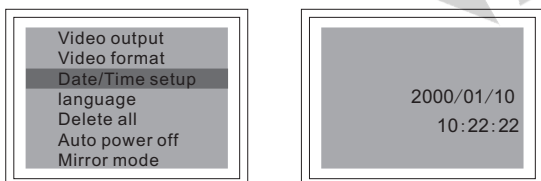

**4.3 Language**

Select language available: English, traditional Chinese, simplified Chinese, Japanese, German.

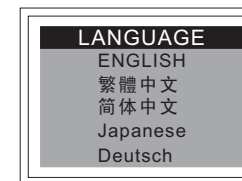
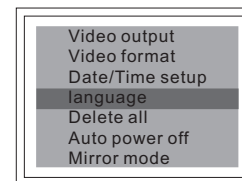

**4.4 Delete all**

Select "delete all", press "up" or "down" to choose "YES" or "NO", then press "OK" to confirm delete all or not.

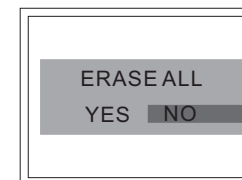
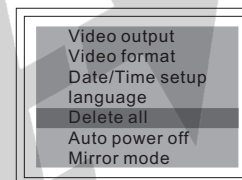

**4.5 Auto power off**

Select "Auto power off", select 5, 10, 15, 30 minutes to power off automatically after the minutes selected. And if choose "Disable", it would never power off.

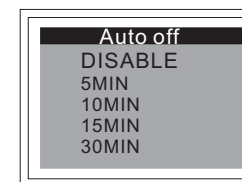
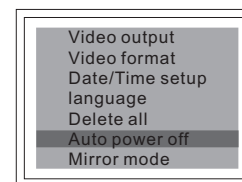

**4.6 Mirror mode**

Select "Mirror mode", the picture would mirror horizontally.



original picture

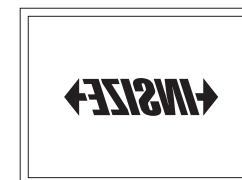

after mirror

**Common problems**

- 5.1 Display nothing after power on: low battery, please charge the battery, if can not charge, please replace the lithium battery.
- 5.2 Only display words but not picture, please check if the lens cable connecting well.
- 5.3 Can not take photos or videos: please check if SD card is inserted. And if SD card broken or full of files, please replace SD card or remove the files to save new pictures or videos.
- 5.4 Can not operate on the main unit: when meeting this problem, just turn off the main unit and press the “Reset” button 1-2 seconds, then turn on the main unit again.

**Specification**

Lens	Diameter	5.5mm
	Pixel	0.3M
	Resolution	640×480
	Frame rate	30fps
	Dust/waterproof probe	IP57
File format	PAL / NTSC	
Power supply	3.7V rechargeable battery (for 3 hours working)	
Memory	2G SD card(about 6000 pictures or 15 minutes video)	
Weight	450g	

**Standard delivery**

Main unit	1 p c
Lens	1 p c
2G SD card	1 p c
AC/DC adaptor	1 p c
video output cable	1 p c
USB cable	1 p c
Battery	1 p c
Clean bar	2pcs