



www.insize.com

INSIZE



**ISH-DSA
DIGITAL SHORE DUROMETER
OPERATION MANUAL**



← IN SIZE →

1. Attention

- ◆ Only authorized charger is allowed to be applied to this, otherwise it will be damaged permanently.
- ◆ Any part of this can't be immersed in the water or be exposed to the rain, otherwise it will be damaged permanently.
- ◆ Origin package is need for long time storage.
Temperature: -30°C~+80°C
Relative Humidity: 5%~95%
- ◆ The battery should be charged fully before first using.
- ◆ This durometer should avoid shock or heavy pressure and can't be exposed to high-intensity magnetic field, high humidity or oil environment.
- ◆ Because the print paper is heat sensitive paper, the paper should avoid high temperature, and direct light. If the print data need to be stored for long time, please make a copy in time.
- ◆ When there are any abnormal phenomenons, please don't try to disassemble or adjust any fixed part. You should fill the warranty card and contact our maintenance department or maintenance agency authorized by our company. Normally, the durometer will not stay in the maintenance department over one week.

2. SUMMARY

2.1 Basic principle

By a given force, the standardized shaped steel needle is vertically pressed into the sample. When the presser foot surface is contact the sample surface, there is a length of L (Figure 3) which is between the tip of the needle and presser foot surface. The value of L indicates the value of SHORE Hardness of the sample. Larger the value of L, smaller the sample's Shore Hardness. Conversely, smaller the value of the L, Larger the sample's Shore Hardness.

The formula is as below:

$$HA = 100 - \frac{L}{0.025}$$

HA means it is types A Shore Hardness. According to this formula as above, the types A Shore hardness is relative to the displacement of the pressed needle. Through measuring the displacement of the pressed needle, the types A Shore Hardness can be calculated.

2.2 Function

- 1) Peak value latching, Average value calculation, Low-voltage alarming.
- 2) Auto power off.

In three minutes, if there isn't any operation, the durometer will be auto power off. Automatically shut down before the buzzer rang five times, to indicate that the machine will automatically shut down.
- 3) Large LCD

The high resolution industry class LCD is applied to this durometer. These make it convenience to read.
- 4) Menu operation and management interface

The operation and management interface is menu type. It is easy to learn and operate.
- 5) Fully data management

This durometer can storage, delete and print the test data. It also can set an interval to sorting samples and accomplish the basic statistics and calculations of the test data.
- 6) The content to be printed can be customized.
- 7) The large capacity rechargeable Ni-MH is built-in.

2.3 Application field

This durometer can be applied to measure hardness of soft plastic and general hardness rubber, such as soft rubber, synthetic rubber, and rubber covered roller, thermoplastic elastomeric, thin film, medical, felt, leather, seal parts, tire, plastic pipe/tape, wire and cable, absorber. It can be widely applied to industry of plastic, rubber and other chemical industry.

7.2 Print report

There are several print modes built-in the durometer. You can select by yourself.

7.2 Auto-print

There are several print modes built-in the durometer. You can select by yourself.

7.2.1 Auto-print

The auto-print command will be carried out during measuring if this function is set to on. The durometer will send the data to the thermal print after the finishing of one statistic group.

7.2.2 Concentration print

The data can't be printed during measuring. You can print the data later. There are two options under this mode: "print selected data" and "print all data" explained as above.

8. Data storage

This durometer can storage 500 group data at most (one group data include: one hardness value, the date/time/sample code).if 500 group data have been saved; no more data can be saved. You need to delete part or all data. If 500 group data have been saved, the screen will display "M FULL" under the measuring interface.

9. Hardness testing

Please press the needle on the sample and make sure the presser foot is contact closely to the sample. When the data is stable, the buzzer will make a sound and the value will show until the next measuring.

Current measuring mode: maximum average value mode
 Current measured value: 58.1HA
 Current statistic times: 5
 The measured number: 2
 Current average value: 57.8HA
 Peak difference: 0.7HA
 Multi-point measuring will be realized by repeating above steps.

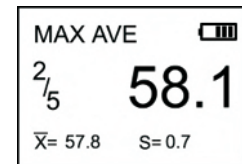

Fig 9-1

5. Low-voltage alarming and recharge

The durometer will be recharged by the packaged charger. The durometer will not be auto power on during recharging. The charging status will show on the measuring interface by hand power on. The moving of the battery level icon line indicate it is charging now. If the icon fill by all line, it means the charging process is finished. If the power is low, the battery level icon will flash to prompt to be recharged in time.

6. Reset

Software reset: if the software abnormal is happened, the durometer will reset automatically.
 Hardware reset: the durometer can be reset by the hardware reset under the crash. The reset button is local in the hole of the back shell.

7. Data printing

Digital durometer can connected to the special mini-thermal printer to print the hardness result report. The mini-thermal printer is optional part. If it is needed, please contact the distributor.
 The printer should be put near to the durometer and the distance shouldn't be over 3m.

7.1 Format of the report

A full report is as the figure 7-2. Ps:1.the print content can be customized by the relative menu explain on above.
 The date/time in the report content is the measuring date/time. The date/time at the end of the report is the print date/time.

History Test Report		
1	60.5HA	Workpiece:15 Date/Time:24/04/2012 18:02
2	29.7HA	Workpiece:15 Date/Time:01/01/2012 00:05
3	55.1HA	Workpiece:15 Date/Time:01/01/2012 00:05
4	89.7HA	Workpiece:15 Date/Time:01/01/2012 00:05
5	2.9HA	Workpiece:15 Date/Time:01/01/2012 00:31
6	1.3HA	Workpiece:15 Date/Time:01/01/2012 00:31
7	80.7HA	Workpiece:15 Date/Time:01/01/2012 00:16
8	100.0HA	Workpiece:15 Date/Time:01/01/2012 00:30
9	100.0HA	Workpiece:15 Date/Time:01/01/2012 00:30
10	100.0HA	Workpiece:15 Date/Time:01/01/2012 00:00

Print Date:05/01/2012		
Print Date:15:43:55		

Fig 7-2

3. Specifications

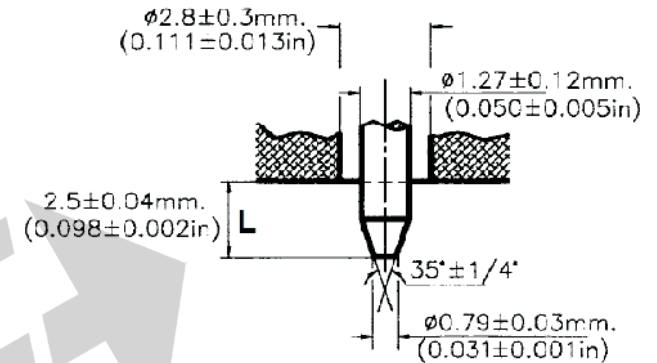

Fig 3

- Measure Range: 0~100HA
- Measure accuracy: $\leq \pm 1 \text{HA}$
- Data capacity: 500
- Voltage: 3.6V (rechargeable Ni-MH battery)
- Continuous working time by one time charge: about 20 hours
- Battery charge time: about 3 hours
- Work temperature: $0^\circ\text{C} \sim +50^\circ\text{C}$
- Work humidity: 20%~85%
- Storage temperature: $-30^\circ\text{C} \sim +80^\circ\text{C}$
- Storage humidity: 5%~95%
- Outline size: 153mm×50mm×29mm (main body)
- Weight: about 169g
- Strut diameter of the needle: $(1.27 \pm 0.12) \text{mm}$
- The top plane diameter of the needle: $(0.79 \pm 0.03) \text{mm}$
- The top cone angle of the needle: Initial verification: $(35 \pm 0.25)^\circ$
 Follow-up test: $(35 \pm 0.75)^\circ$

4. Operation Instructions

4.1 Button and measure interface

4.1.1 Button

- Power/Return : By pressing this button, the durometer will be power on. By long time pressing this button, the durometer will be power off. By pressing this button, the screen will return to the upper level menu.
- OK : Under the measure interface, it will enter the menu interface by pressing this button. Under the menu interface, it will enter the next menu interface. In addition, it is the confirmation button under function selection or parameters setting interface.

- UP: Under the menu interface, the selection will be shifted up by pressing this button. Under parameters setting interface, the value will increase by pressing this button.
- DOWN: Under the menu interface, the selection will be shifted down by pressing this button. Under parameters setting interface, the value will decrease by pressing this button. Under some parameters setting interface, the selection will be moved down by pressing this button.

4.1.2 Interface

The large and high resolution LCD is applied to this durometer, so this durometer has the advantage of fully information display and easy to read etc.

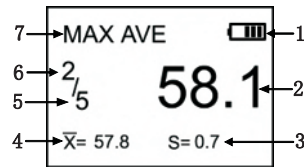

Fig 4-1

1. Battery level: Indicating the battery level or charging status
2. Hardness value: The current measured hardness value
3. Peak difference: The difference between the maximum value and the minimum value of this data group
4. Average value: the average value of this data group
5. Statistic times: the measure times of one statistic group
6. Current times: Indicating the current times
7. Measure mode: Indicating the current measure mode
 AVE: Average measure mode
 Max: Maximum value measure mode
 MAX AVE: Maximum average value measure mode

4.2 Menu

Hardness tester has multi-level menu interface. The system setting can be finished by simple operation. The menu structure is showed in Figure 4-2. The first page of the main menu is showed in figure 4-3. The second page of the main menu is showed in figure 4-4.

4.2.5.2 Print Items setting

Whether the date/time will be print can be set under this menu.



Fig 4-25

4.2.5.3 Print the selected data

Firstly, the range of data to be printed should be set. After the setting is finished, the print command will be carried out by pressing button "OK". The print command will not be carried out by pressing button "RETURN".



Fig 4-26

4.2.5.4 Print all data

The prompt window will be pushed out under this menu. All data will be printed by selection of "YES" and this operation will be aborted by selection of "NO".

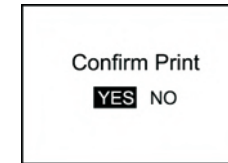

Fig 4-27

4.2.6 Software information

The logo and software version will be showed under this menu. AABCC on behalf of the date of manufacture: AA means year, BB means month, CC means date.

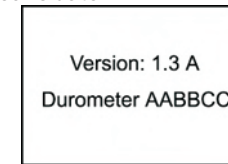

Fig 4-28

4.2.4.4 Delete the selected data

The range of data to be deleted should be setup under this menu. The selected data will be deleted by pressing button "OK". It will be aborted by pressing button "RETURN".

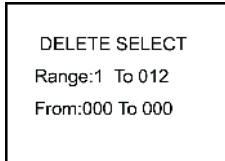

Fig 4-22

4.2.4.5 Delete all data

The prompt window will be pushed out under this menu. All data will be deleted by selection of "YES", and this operation will be aborted by selection of "NO".

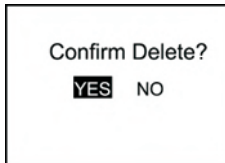

Fig 4-23

4.2.5 Print setting

The data saved in the durometer can be printed by the thermal printer.

4.2.5.1 Auto-print ON/OFF setting

The durometer will send the data to the thermal print after the finishing of one statistic group under this function is set as on. Otherwise, the durometer will not send data to the thermal print.

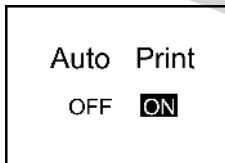

Fig 4-24

Menu	Software calibration	Software calibration
	Measure setup	Measure mode setting
		Measure times setting
		Tolerance limit setting
		Grubbs error handling ON/OFF setting
		Sample code setting
	System setup	Time, date setting
		Backlight time
		Pressing-button sound
		Alarm sound
	Storage management	Browse from the first data
		Browse from the last data
		Browse from the selected data
		Delete the selection data
		Delete all data
Print setting	Auto-print setting	
	Print Items	
	Print the selected data	
	Print all saved data	
Software information	software information	

Fig 4-2

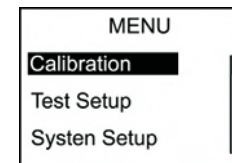

Fig 4-3

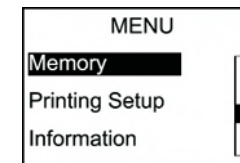

Fig 4-4

4.2.1 Calibration

Pressing button “OK” to enter the menu, select “Calibration”, press button “OK”. The durometer can be calibrated by Glass plate, standardized thickness block or other rubber whose hardness is known. Make the press needle of the durometer press on the glass plate, standardized thickness block or other rubber whose hardness is known. Keeping the presser foot contact the samples closely for a while to stabilize, the LCD show the hardness value. If the hardness value is different from the theory value (calibration value), please enter the theory value. If the glass plate is applied, please enter 100. If the standardized thickness block is applied, please enter 50. If the rubber whose hardness is known is applied, please enter the rubber's hardness.

Values enter method: under the enter value status, the corresponding position will flash, press “UP” to adjust the number, press “DOWN” to shift to the next position, press “RETURN” to abort the calibration, press “OK” to confirm the calibration.

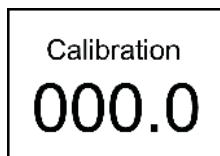

Fig 4-5

4.2.2 Measure setting

Under measure setting, the measure mode, measure times, tolerance limit, on or off of gross error processing setting, sample code can be set. The first page of measure setting menu is showed in figure 4-6. The second page of measure setting menu is showed in figure 4-7.

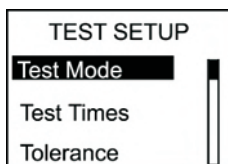

Fig 4-6

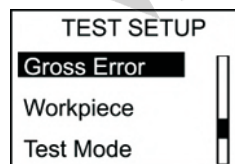

Fig 4-7

4.2.3.4 Alarm sound setting

If this function is set as on, the durometer will make a sound of alarm when the data is exceed the tolerance limit.

The selection will be modified by pressing button “UP” or “DOWN”. The selection will be confirmed by press button “OK”. The selection will be aborted by press button “RETURN”.

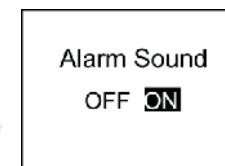

Fig 4-18

4.2.4 Storage management

4.2.4.1 Browse from the first data

The first page data will be show when enter this menu (8 data per page).it will turn to the next page by pressing button “DOWN”. The selection will be shifted by pressing button “UP”. The measure date/time/sample code of the selected data can be show by pressing button “OK”.

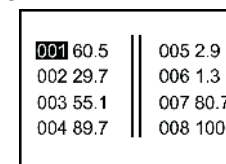

Fig4-19

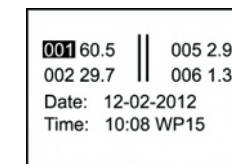

Fig 4-20

4.2.4.2 Browse from the last data

The last page data will be show when enter this menu(8 data per page).it will turn to the previous page by pressing button “UP” .The selection will be shifted by pressing button “DOWN” .The measure date/time/sample code of the current data can be show by pressing button “OK”.

4.2.4.3 Browse the selected data

The range of data to be browse should be setup under this menu. The first page of selected data will be show by pressing button “OK”. It will turn to the next page by pressing button “DOWN”. The selection will be shifted by pressing button “UP”. The measure date/time/sample code of the current data can be shown by pressing button “OK”.



Fig 4-15

4.2.3.2 Backlight time setting

Under this menu, the continued lighting time of the backlight can be set.

- 0s: The backlight will be turned off all times
- 15s: The backlight lighting 15 second every time.
- 30s: The backlight lighting 30 second every time.
- 45s: The backlight lighting 45 second every time.
- 60s: The backlight lighting 60 second every time.
- Disable: the backlight will light all the time.

The selection will be modified by pressing button "UP" or "DOWN". The selection will be confirmed by press button "OK". The selection will be aborted by press button "RETURN".

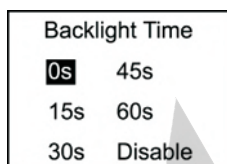

Fig 4-16

4.2.3.3 Key sound setting

The key sound can be turn on or off by this setting.

The selection will be modified by pressing button "UP" or "DOWN". The selection will be confirmed by press button "OK". The selection will be aborted by press button "RETURN".

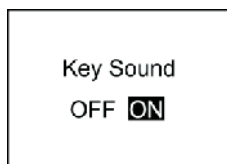

Fig 4-17

4.2.2.1 Measure mode

Under the menu of measure mode, there are three kinds of mode: Average value mode, maximum value mode and maximum average value mode.

1. Average value mode: During one sampling process, the durometer will record 20 values and calculate the average value of this 20 value automatically.

The average value will show on the screen. Under this mode, the statistic times can be set. After one measure process is finished, the durometer will calculate the average value and peak difference of the data until now automatically. If the statistic time is meet, the last average value will be saved as the measure result.

2. Maximum value mode: During one sampling process, the durometer will record 20 values automatically and take the maximum value as the current result. Under this mode, the statistic times can't be set.

3. Maximum average value mode: During one sampling process, the durometer will record 20 values automatically and take the maximum value as the current result. Under this mode, the statistic times setting can be set. After one measure process is finished, the durometer will calculate the average value and peak difference of the data until now automatically. The average value of maximum value of every measuring will be calculated and this value will be taken as the last result.

4.2.2.2 Measure times setting

The statistic times can be set under this menu. The statistic times will increase 1 by one pressing of button "UP". The statistic times will decrease 1 by one pressing of button "DOWN". The continuous increasing or decreasing will be realized by keep pressing the button "UP" or "DOWN". The maximum statistic times setting is 9.

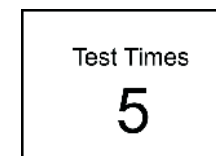

Fig4-9

4.2.2.3 Tolerance limit setting

Under this menu, the tolerance limit can be set. When the measuring data is exceed the setting value, the icon of “!” will be showed on the LCD and it will flash. If the alarm function is turn on, the durometer will make the alarm sound.

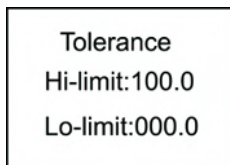

Fig 4-10

4.2.2.4 Gross error handling ON/OFF setting

Under this menu, the gross error handling can be set to on or off during the measuring process.(the gross error handling is available only under the average mode and maximum average mode).If the gross error handling function is turn on, the gross error analysis will be applied to the current group when a statistic group is formed(the measure times meet the setting time),and the gross error data will be taken as invalidated data to be abandoned during the calculating of average value and peak difference. If the auto-print function is turn on, a symbol of “!” will be marked after the gross error data. If the gross error handling function is turn off, the gross error analysis will not be carried out after the statistic group is formed, all data of the statistic group will be taken as valid value to calculate the average value and peak difference.

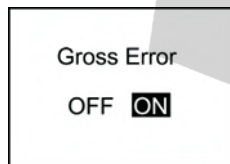

Fig 4-11

4.2.2.5 Sample code setting

When several samples is need to be measured, the samples can be coded (figure 4-12). The value of setting position will increase 1 by one pressing of button “UP”. The position shift to the next position by one pressing of button “DOWN”. The coded range is 00-99. When the date saved, the sample code saved too. The samples number corresponding to the data can be printed (figure7-2). It also can be looked up during data browsing (figure4-21).

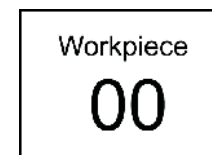

Fig 4-12

4.2.3 System setting

Under system setting menu, the date/time, backlight time, on or off of key sound, on or off of alarm sound can be set.

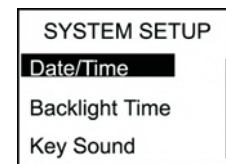

Fig 4-13

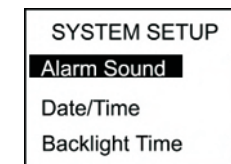

Fig 4-14

4.2.3.1 Date/time setting

Under this menu, year, mnth, day, hour, minute, second can be set. The selection will increase 1 by one pressing of button “UP”. It will return to 1 when it exceeds the range. The continuous increasing of 1 can be realized by long pressing of the button “UP” .The selection will shift to the next one by press button “DOWN”. The setting will be confirmed by press button “OK” .The setting will be aborted by press button “RETURN”.