



[www.insize.com](http://www.insize.com)

INSIZE



**ISH-BRV  
BRINELL/ROCKWELL/VICKERS  
HARDNESS TESTER  
OPERATION MANUAL**



## Attention

- ◆ The power socket for this apparatus shall be of a one-way 3-pin type, the earth terminal shall meet the specified requirements of grounding protection.
- ◆ This instruction manual shall be read through prior to the use of the apparatus, to understand the detailed operation steps and special attentions, in order to prevent apparatus damage and/or personal injury resulted from improper operation.
- ◆ All bands and shake-reducing tapes shall be carefully removed before apparatus installation and calibration.
- ◆ It is strictly prohibited to tamper with the installation position of all electric elements. Switches, sockets etc. It may cause damage and/or injury.
- ◆ It is not permitted to rotate the pressure selecting hand-wheel or lifting screw during the testing pressure charging or relieving period or during the pressure keeping pressure.

## Description

### ① General descriptions:

The hardness is one of the important parameters to determine the mechanical properties of the material, and the hardness test is a way which is used to discriminate and determine the quality of metallic materials or components of the product. The so-called hardness is meant the capability of the material which, under a certain condition, is capable to resist the press-in of another matter which will not produce residual deformation itself. The larger the resisting power is, the higher the hardness will be, and vice versa.

In the course of testing the mechanical properties, hardness measurement is the easiest, most economical, and rapidest method, and is also one of the measures which are used to inspect the quality of the product during manufacturing the machine. As the metallic hardness possesses the mutual corresponding relationship with certain other mechanic properties, hence, most metallic materials may approximately infer their other mechanical properties such as strength, fatigue, creep, wearing and internal damages etc. by determining their hardness.

Following the daily growing development of the industrial and agricultural production as well as the scientific technology, various kinds of different requirements are also demanded to the hardness tester itself, especially it demands high precision in measurement and test, and may carry out various kinds of hardness test for different kinds of materials. Based upon this, the model ISH-BRV Brinell, Rockwell and Vickers hardness tester which is produced by our factory possesses the conditions which fulfill all the above mentioned requirements.

### ② Main application and characteristics:

This hardness tester possesses multistage test forces and many kinds of indenters (table 1) which are used to measure and determine the Brinell, Rockwell and Vickers hardness of the metallic materials or test pieces. It is adaptable for determining the hardness of ferrous metals (steel, cast iron pieces, mild steel and quenched steel etc.) and non-ferrous metal (aluminium alloy and

copper alloy etc.), meantime it may also be used to determine the hardness of hard alloy, carburized layer and chemically treated layer. When purchasing, in case the necessary accessory such as surveying microscope is not bought simultaneously, you may also carry out the Brinell, Vickers hardness tests under the cooperation of self-furnished surveying microscope.

The model ISH-BRV Brinell, Rockwell & Vickers hardness tester adopts rotating type load changing mechanism as well as optical measurement indicating system, and the microscopic survey installation is mounted on the body of the apparatus. Hence, it is convenient, sensible and reliable in the loading measuring system, high precision in the shown value, it is widely adaptable to the factory workshop, laboratory, university, college and school as well as scientific research institute.

Table 1

Type of test	Test force (N)		Symbol of hardness value	Indenter	Measuring installation	Examples of Measured & tested materials
	Primary test force	Total test force				
Rockwell hardness test	98.07	588.4	HRA	diamond cone indenter	Optical measurement indicating mechanism	hard alloy, carbon carburizing steel, quenched steel, adjustable quality steel, hard cast iron
		1471	HRC			
		980.7	HRB			
Brinell hardness test	306.5 612.9 1839		HB	φ2.5, φ5mm steel ball indenter	Surveying microscope	Non-ferrous metal, cast iron, soft alloy, plastics
Vickers hardness test	294.2 980.7		HV30	diamond angle conical indenter	Surveying microscope	The superficial hardness of metallic alloy, carburized layer, small type thin components

3 Parts descriptions:

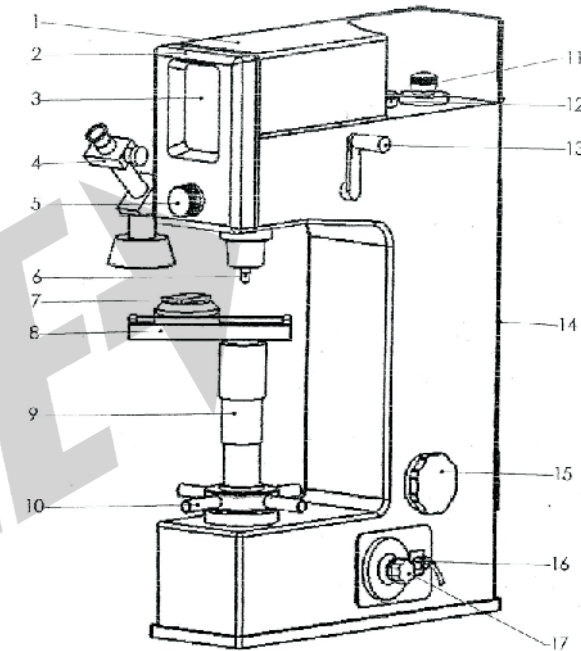

1. Top cover
2. Veil
3. Rockwell display
4. Microscope
5. The micro-adjusting knob
6. The indenter
7. The test piece
8. Slider
9. Dust cover
10. Rotating wheel for lifting and lowering
11. Buffer adjusting hand wheel
12. Light source adjusting hand wheel
13. Loading and unloading handle
14. Rear cover
15. Load changing hand wheel
16. The fuse plug
17. The power switch

**Installation And Adjustment**

1 Working conditions of the tester:

- ◆ Under ambient temperature, i.e. between 10-30 °C;
- ◆ The relative humidity in test room shall not be over 65%;
- ◆ In an environment free from vibration;
- ◆ No corrosive medium in surrounding.

- 2 Tester unpacking:
- ◆ Open the packing box cover and take out all cushion materials. Remove the accessory box.
  - ◆ Lift the bottom plate, unscrew the two (2) M 10 bolts under the bottom plate with a spanner, to separate the hardness tester from bottom plate, all steps shall be done in a safe manner.
  - ◆ After unpacking, the tester shall be placed on a stable bench with levelness deviation less than 1 mm/m. A hole shall be drilled at an appropriate location on the bench (see fig 1) to enable the lifting screw to operate properly.

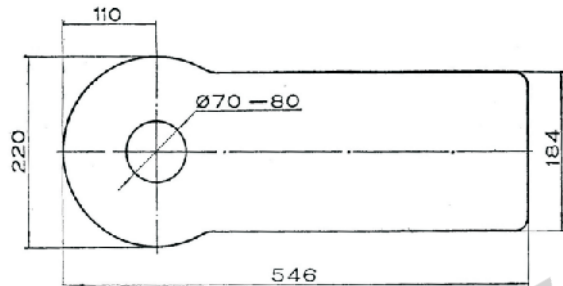

Fig. 1

- 3 After the installation of the hardness tester, take away the external white gauze strip of the machine. Remove the dust cover, use gasoline to clean the antirust grease on the lifting and lowering screw rod. After it is dried, coat with certain amount of thin grease for lubrication. Then, unscrew the screws on the upper cover and rear cover respectively, and open the upper cover and rear cover, and unloosen the white gauze strip and rubber band which are inside the machine and take out the oblique shape EPS which is under the screw rod. In the course of operation, pay attention not to touch the optical elements. After completion, close the upper cover in time.
- 4 Installation of weight set:  
Turn the load adjustment hand wheel to the point of 306N, install the small "0" weight on to the hanging hook which is on the upper part of the suspended lever, then place the other 4 weights according to the sequence of No. 4, 3, 2, 1, respectively from the bottom to the top on to the tray, and observe whether the installation is correct or not .

- 5 Adjustment of the loading speed:  
Oil contained in the buffer has already been fully drawn out before packaging and leaving the factory, hence, before use, oiling the necessary. Turn the adjustment handle counter clockwise to unloosen the needle valve, open the dust cover plate of the oil filler hole, and push the loading handle backward in the direction, use a needle tube to inject some 50 ml grease Then pull slowly the loading handle back and forth, repeat in this way many times so as to make the extra grease overflow from the oil filler hole, erase away the overflow grease, then close the dust cover plate.  
Adjust the loading speed of the buffer: switch on the power supply, and place the test platform. Turn the loading handle counterclockwise to pull it forward, so as to uplift the screw rod slowly, when the test platform touches the plane of the surveying rod (at that time, the indenter is not mounted yet) uplift the screw rod continuously. When the oblong signal displayed in the reading projecting screen and the target rod gradually uplift. Finally, when the base line and the fixed target rod of the projecting screen coincide, then stop to uplift the screw rod and pull the handle backward by turning the handle in a clockwise direction, at that time, the buffer start its action, the target rod and the signal start to lower gradually, the quickness and slowness of the lowering speed will be adjusted by the buffer adjustment handwheel.
- 6 Adjusting the clarity of the projecting target rod:  
After switch on the power supply, in case it is discovered that the projecting target rod is dim and not clear, you may rotate the knurled nut in order to make the lamp revolve or uplift, then tighten the knurled nut.
- 7 Installation of the microscope:  
The microscope which has its internal lighting system is mounted on the left clamping chuck of the machine body by means of its cooperation with the sliding plate test platform, it is capable to test the Brinell and Vickers hardness of the metallic materials.
- ◆ When carrying out the Brinell, Vickers hardness test, first, mount the sliding plate test platform on the axial hole of the lifting and lowering screw rod, and fix it by nuts.

- ◆ The microscope shall be perpendicularly fixed on the clamping chuck, and install the exterior lighting lampshade which is used for testing the Brinell hardness.
- ◆ Use a plug to switch on the power supply, the lamp spigot is situated on the edge of the bakelite cover.
- ◆ Based upon the test method, select and mount the objective, generally, for the Brinell hardness test, use 2.5x objective, for the Vickers hardness test, use 5x objective.
- ◆ Press several indentations step by step on the standardized test blocks, remove the upper sliding plate under the microscope to look for the indentation. The sliding plate which makes use of the axis hole of the lifting and lowering screw rod as its centre makes circumferential rotation and carefully makes the upper and lower adjustment, align to the focal distance until the indentation appears in the centre of the visual field, then tighten the nut, after completion of the preparation, it is ready for test.

### Inspection the precision

After making adjustment for the hardness tester according to the above mentioned methods, then make the shown value precision inspection for the hardness block.

#### 1 Rockwell hardness test:

Measure and determine six points on the different positions of the working surface of the standardized Rockwell hardness block, the central distance of two adjacent indentations and the distance from the center of the indentation to the edge of the hardness block shall not be less than 3 mm. give up the first point, then take the mean value of the rest five points, the difference between the mean value and the standardized hardness block is the shown value error of the hardness tester. The error shall not exceed  $\pm 1$  HR.

Within the five points, the difference between the maximum value and the minimum value shall not exceed that specified in the following:

Target rod A is 1.0 HR

Target rod B is 1.2 HR

Target rod C: HRC 35 - 67 is 1.0 HR

HRC 20 - 35 is 1.2 HR

#### 2 Brinell hardness test:

Measure and determine five points which are evenly distributed on the standardized Brinell hardness block, the central distance between two adjacent indentations shall not be less than 4 times the diameter of the indentation. The distance from the center of the indentation to the edge of the hardness block shall not be less than 2.5 times the diameter of the indentation. The measurement for the diameter of each indentation is carried out on two directions which are mutually perpendicular, and take the mean value. The ratio between the difference of the two mutually perpendicular diameter and the shorter diameter shall not be greater than 1%.

Divide the difference between the mean hardness value of the five points measured according to the above mentioned method and the standardized hardness value by the hardness value of the standardized block, this is the shown value error of the hardness tester. When the test force is greater than 1839N, the tolerance allowed is  $\pm 3\%$ ; when the test force is less than 1839N, the tolerance allowed is  $\pm 4\%$ .

Divide the difference between the maximum value and the minimum value of the hardness values of the five points by the mean hardness value of the 5 points, for the hardness block of 30D , 10D , it shall not exceed 3.5%; for the hardness block of 2.5D , it shall not exceed 5.0%.

#### 3 Vickers hardness test:

Measure and determine 5 points which are evenly distributed on the standardized Vickers hardness block, the distance between the center of the two adjacent indentations and the distance from the centre of the indentation to the edge of the hardness block shall not be less than 2.5 times the diagonal length of the indentation. Measure the two diagonals for every indentation and take its mean value.

The ratio between the difference of two diagonals to the shorter diagonal shall not be greater than 2%.

Divide the difference between the mean hardness value of the 5 points measured and determined according to the above mentioned method and the hardness value of the standardized block by the hardness value of the standardized block, this is the shown value error of the hardness tester. The allowable tolerance is  $\pm 2\%$ .

Divide the maximum value and the minimum value of the hardness values of the 5 points by the mean hardness value, this is the changeable value of the hardness tester. The allowable tolerance is 2.5%.

The shown value precision of the hardness tester has been adjusted before leaving the factory. In case error produced due to vibration in the course of transportation, the testing personnel shall make suitable adjustment on the basis of understanding its structural principles. Take away the upper cover, if the shown value measured is greater than the marked value of the hardness block, when it is required to lower the hardness reading, then you may use a screwdriver to turn clockwise one degree of the slotted countersunk head screw 2 which is on the spring leaf, meantime tighten one degree of the slotted countersunk head screw 1 by turning it counter clockwise of the optical lever (Fig. 2). Note the rotated degree should be basically conformed. Test the shown value again, until it is adjusted within the specified range of error.

If the shown value measured is less than the standardized block, than the revolving direction of the screw shall be reversed.

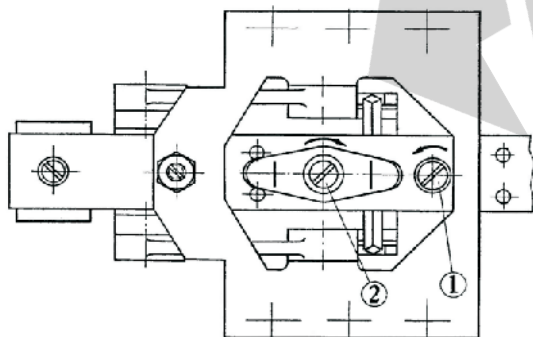
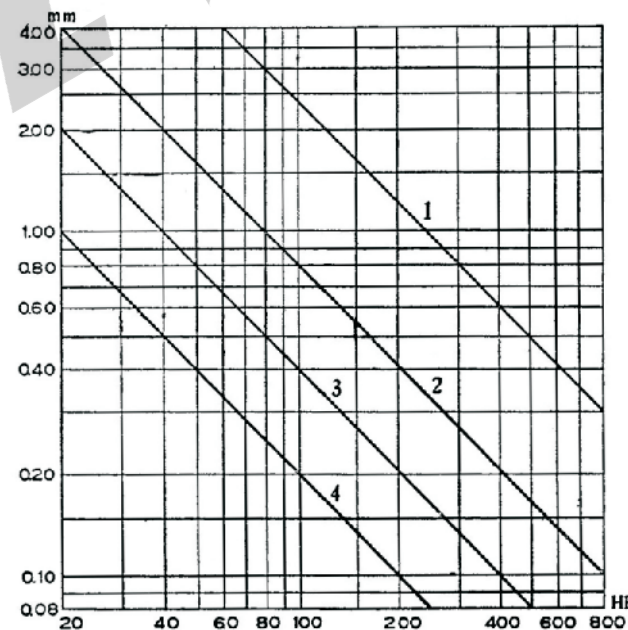

Fig. 2

### Operation

1 The preparing work before test:

- ◆ Switch on the power supply, based upon the test method, open the switch.
- ◆ The surface of the sample to be tested shall be level, bright and clean, it shall not present any outstanding machining traces such as pollutants, oxidized flakes, cracks and pockets etc.
- ◆ The supporting surface of the sample and the test platform shall also keep clean, so as to ensure better closely engaged, the relationship between the minimum thickness of the sample and the hardness may refer to table 2, table 3 and table 4.
- ◆ Table 2: The relationship between the minimum thickness and hardness HB





- Line 1: The diameter of the steel ball is  $\varnothing 2.5\text{mm}$ .  
Test force : 1839N
- Line 2: The diameter of the steel ball is  $\varnothing 2.5\text{mm}$ .  
Test force: 612.9N
- Line 3: The diameter of the steel ball is  $\varnothing 2.5\text{mm}$ .  
Test force: 306.5N
- Line 4: The diameter of the steel ball is  $\varnothing 2.5\text{mm}$ .  
Test force: 306.5N

◆ Table 3: The relationship between the minimum thickness and hardness HRC, HRB

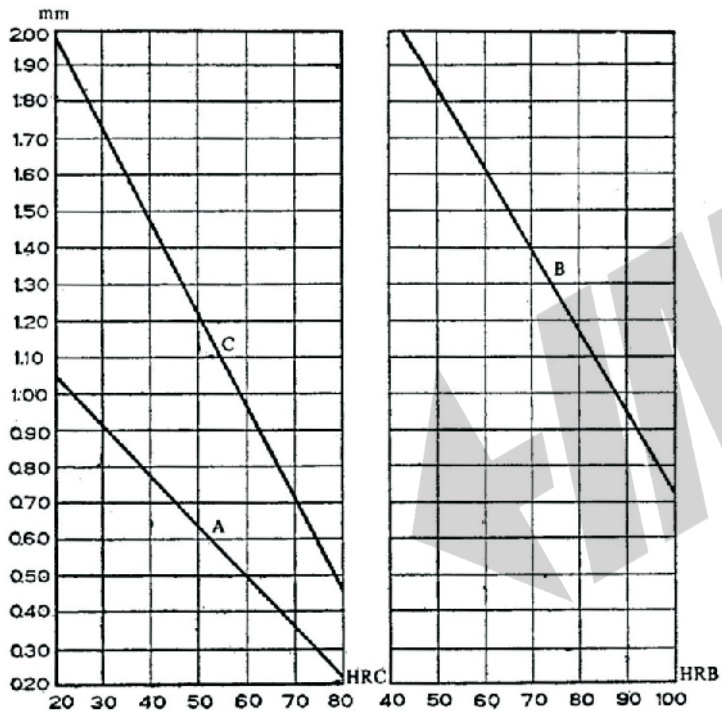

◆ Table 4: The relationship between the minimum thickness and hardness HV

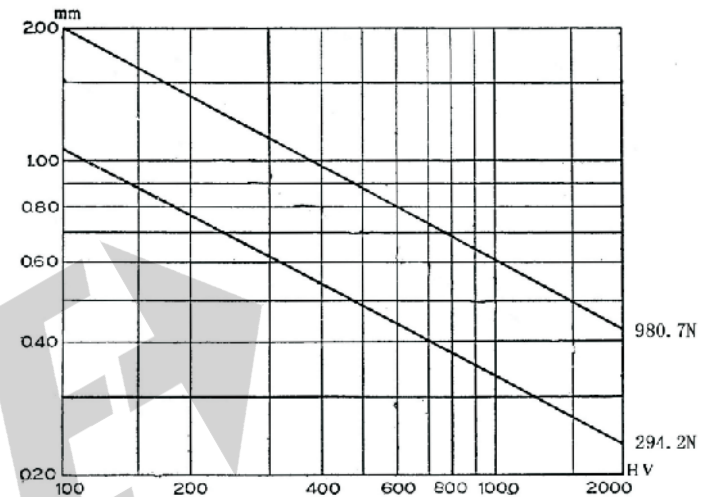

- ◆ According to the shape of the test piece, select suitable platform. If the test piece is special shaped, the test platform which is attached together with this hardness tester cannot meet the requirement, then you should base upon the geometric shape of the test piece to design a special test platform by yourself.
- ◆ Turn the loading handle of the hardness tester counter clockwise to push it forward, so as to make the load in an unloading state.

② Procedures for test:

- ◆ Select the indenter according to the hardness test method (table 1). Insert the handle of the indenter into the axial hole of the surveying rod and slightly turn the fixed screw.
- ◆ Select the test force according to the hardness test method. Turn the changing handwheel clockwise, in order to make the loading figures needed correspond to the fixed calibrated line.

**Note:** When the test force used is 294.2N, you should open the rear cover, take away all weights including the small "0" weight.

- ◆ Place the test piece reliably on the test platform, then turn the rotating wheel to make the screw rod lift upward, when the test piece is in contact with the indenter, the projecting target rod will lift correspondingly, finally, keep the baseline of the target rod

approximately coincide with the fixed line of the projecting screen. The difference allowed may be ±5 degree value.

- ◆ Use the micro-adjustment knob to adjust the zero digit, so as to keep the base line of the target entirely coincide with the projecting screen.. If the knob is turned to the limit position, the two lines are still not able to coincide, then it shall be unloaded, and turn the micro-adjusting knob to the intermediate position, and select another point on the test piece, then repeat the above mentioned operations again.
- ◆ Push the loading handle forward by turning it clockwise, during loading, the calibrated line of the target rod which is displayed on the projecting screen is moving up and down, until the target rod stops to lower, then start to compute the load holding time until the load holding time is reached, then pull the handle again to its original position.
- ◆ The reading which is the indicating target rod calibrated line on the projecting screen to the fixed target rod line is the Rockwell hardness value of the tested specimen.. Lower the screw rod, make the test piece leave the indenter, move to another position and repeat the above mentioned test.

3 The Brinell and Vickers hardness test shall, after the completion of the above mentioned procedures, move the upper sliding plate and the test piece together under the microscope, then gradually uplift the screw rod micro-quantitatively, align it to the focal distance, and make the image of the indentation distinct, then measure the diameter of the indentation or the diagonal length of the indentation, next, look over the attached table and obtain the Brinell or Vickers hardness value. When purchasing, the surveying microscope which forms a complete set of the apparatus is not obtained, then you may carry out the survey by means of your own prepared surveying microscope.

The computing method of the surveying microscope against the indentation is as follows:

L -- the diameter of the indentation or the diagonal length in mm.

n -- number of division line measured from the indentation (i.e. the difference between the first reading and the second reading).

l -- the minimum calibrated value of the surveying microscopic drum wheel

It is 0.004 mm when 2.5x objective is used.

It is 0.002 mm when 5x objective is used.

For instance: Use a 5x objective to measure the Vickers indentation of a 294.2N test force.

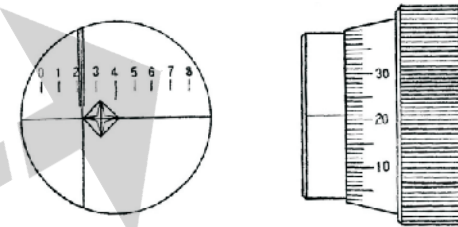

- ◆ The first reading is 221 division line.

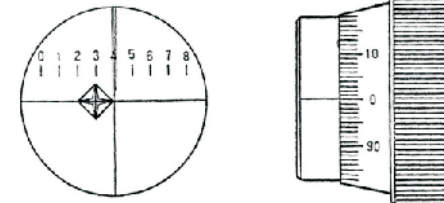

- ◆ The second reading is 400 division line.  
According to this indentation:  
 $L = n \times l = (400-221) \times 0.002 = 0.358 \text{ mm}$ .  
Look over the attached table, we obtain 434HV  
If the Brinell hardness test is carried out, the method of calculation is identical.  
 $L = n \times l \times b$  when test the Brinell hardness.  
b--Indenter coefficient.  
When use Ø2.5mm steel ball indenter b is 4.  
When use Ø5mm steel ball indenter b is 2.



## Maintenance

Maintenance of hardness tester and matters to be noted:

- ① The test personnel shall abide by the operating regulations, the hardness tester shall be used and maintained by assigning special person.
- ② The apparatus shall be in a state of unloading when turning the changing hand wheel.
- ③ In the course of test, when the test piece and indent mutual contact, they shall be slow and stable.
- ④ After the completion of test, you shall keep the apparatus in a state of unloading, covered by a dust cover, the indenter and the hardness block shall be coated with vaseline against rust.
- ⑤ With the exception of the lifting and lowering part of the screw rod which shall be coated with little amount of lubricant, all of the other parts of the hardness tester shall not be coated or injected with any kind of lubricant.
- ⑥ When transporting the apparatus, the oil in the buffer shall be drawn off, the transportation shall be carried out with its bottom supported, no lean down to the transverse direction is allowed, it is not allowed to touch the handle during transportation. When transporting, fasten the optical lever by rubber band and take away the weights and suspended lever.

## Specification

Rockwell test load	98N preload, 588, 980, 1471N total load
Min. Rockwell reading	0.5HR
Brinell test load	306, 613, 1839N
Vickers test load	294N
Stage elevation	manual
Load control	manual
Magnification of microscope	37.5X/75X (selectable)
Max. workpiece height	180mm
Max. workpiece depth	200mm(from the center of indenter)
Dimension	546×300×767mm
Weight	90kg

## Standard Delivery

Main unit	1pc
Ø1.5875mm carbide ball indenter	1pc
Diamond Rockwell indenter	1pc
Ø5mm Brinell indenter	1pc
Ø2.5mm Brinell indenter	1pc
Vickers indenter	1pc
Ø60mm flat anvil for Rockwell	1pc
Ø150mm flat anvil for Rockwell	1pc
V-anvil for Rockwell	1pc
Flat anvil for Vickers and Brinell	1pc
V-anvil for for Vickers and Brinell	1pc
Rockwell test block HRC (high, low)	1pc of each
Rockwell test block HRB	1pc
Brinell test block	1pc
Vickers test block	1pc
Anti-dust cover	1pc

**Comparison Table Of Vickers Hardness**

D (mm)	Test Force 294.2N									
	0	1	2	3	4	5	6	7	8	9
0.23	—	—	—	—	—	—	—	—	—	—
0.24	966	958	950	942	934	927	919	912	905	897
0.25	890	883	876	969	862	856	849	842	836	829
0.26	823	817	810	804	798	792	786	780	775	769
0.27	763	757	752	746	741	736	730	725	720	715
0.28	710	705	700	695	690	685	680	675	671	666
0.29	661	657	652	648	644	639	635	631	626	622
0.30	618	614	610	606	602	598	594	590	589	583
0.31	579	575	571	568	564	561	557	554	550	547
0.32	543	540	537	533	530	527	523	520	517	514
0.33	511	508	505	502	499	496	493	490	487	484
0.34	481	478	476	473	470	467	465	462	459	457
0.35	454	452	449	446	444	441	439	436	434	432
0.36	429	427	425	422	420	418	415	413	411	409
0.37	406	404	402	400	398	396	393	391	389	387
0.38	385	383	381	379	377	375	373	371	370	368
0.39	366	364	362	360	358	357	355	353	351	349
0.40	348	346	344	343	341	339	337	336	334	333
0.41	331	329	328	326	325	323	321	320	318	317
0.42	315	314	312	311	309	308	307	305	304	302
0.43	301	299	298	297	295	294	293	291	290	289
0.44	287	286	285	283	282	281	280	278	277	276
0.45	275	274	272	271	270	269	268	266	265	264
0.46	263	262	261	260	258	257	256	255	254	253
0.47	252	251	250	249	248	247	246	245	243	242
0.48	241	240	239	238	237	237	236	235	234	233
0.49	232	231	230	229	228	227	226	225	224	222

D (mm)	Test Force 294.2N									
	0	1	2	3	4	5	6	7	8	9
0.50	223	222	221	220	219	218	217	216	216	215
0.51	214	213	212	211	211	210	209	208	207	207
0.52	206	205	204	203	203	202	201	200	200	199
0.53	198	197	197	196	195	194	194	193	192	191
0.54	191	190	189	189	188	187	187	186	185	185
0.55	184	183	183	182	181	181	180	179	179	178
0.56	177	177	176	176	175	174	174	173	172	172
0.57	171	171	170	169	169	168	168	167	167	166
0.58	165	165	164	164	163	163	162	161	161	160
0.59	160	159	159	158	158	157	157	156	156	155
0.60	155	154	154	153	152	152	151	151	150	150
0.61	150	149	149	148	148	147	147	146	146	146
0.62	145	144	144	143	143	142	142	142	141	141
0.63	140	140	139	139	138	138	138	137	137	136
0.64	136	135	135	135	134	134	133	133	132	132
0.65	132	131	131	130	130	130	129	129	128	128
0.66	128	127	127	127	126	126	125	125	125	124
0.67	124	124	123	123	122	122	122	121	121	121
0.68	120	120	120	119	119	119	118	118	118	117
0.69	117	117	116	116	116	115	115	115	114	114
0.70	114	113	113	113	112	112	112	111	111	111
0.71	110	110	110	100	109	109	109	108	108	108
0.72	107	107	107	106	106	106	106	105	105	105
0.73	104	104	104	104	103	103	103	102	102	102
0.74	102	104	104	104	101	100	100	99.7	99.4	99.2
0.75	98.9	98.6	98.4	98.1	97.9	97.6	97.3	97.1	96.8	96.9
0.76	96.3	96.1	95.8	95.6	95.3	95.1	94.8	94.6	94.3	94.1
0.77	93.8	93.6	93.3	93.1	92.9	92.6	92.4	92.1	91.9	91.7
0.78	91.4	91.2	91.0	90.7	90.5	90.3	90.0	89.8	89.6	89.4
0.79	89.1	88.9	88.7	88.5	88.2	88.0	87.8	87.9	87.4	87.1

D (mm)	Test Force 294.2N									
	0	1	2	3	4	5	6	7	8	9
0.80	86.9	86.7	89.5	86.3	86.1	85.8	85.6	85.4	85.2	85.0
0.81	84.8	84.6	84.4	84.2	84.0	83.8	83.5	83.3	83.1	82.9
0.82	82.7	82.5	82.3	82.1	81.9	81.7	81.5	81.3	81.1	80.9
0.83	80.8	80.6	80.4	80.2	80.0	79.8	79.6	79.4	79.2	79.0
0.84	78.8	78.7	78.5	78.3	78.1	77.9	77.7	77.5	77.4	77.2
0.85	77.0	76.8	76.6	76.5	76.3	76.1	75.9	75.7	75.6	75.4
0.86	75.2	75.0	74.9	74.7	74.5	74.4	74.2	74.0	73.8	73.7
0.87	73.5	73.3	73.2	73.0	72.8	72.7	72.5	72.3	72.2	72.0
0.88	71.8	71.7	71.5	71.4	71.2	71.0	70.9	70.7	70.5	70.4
0.89	70.2	70.1	69.9	69.8	69.6	69.4	69.3	69.1	69.0	68.8
0.90	68.7	68.5	68.4	68.2	68.1	67.9	67.8	67.6	67.5	67.3
0.91	67.2	67.0	66.9	66.7	66.6	66.4	66.3	66.2	66.0	65.9
0.92	65.7	65.6	65.4	65.3	65.2	65.0	64.9	64.7	64.6	64.5
0.93	64.3	64.2	64.0	63.9	63.8	63.6	63.5	63.4	63.2	63.1
0.94	63.0	62.8	62.7	62.6	62.4	62.3	62.2	62.0	61.9	61.8
0.95	61.6	61.5	61.4	61.3	61.1	61.0	60.9	60.7	60.6	60.5
0.96	60.4	60.2	60.1	60.0	50.9	59.7	59.6	59.5	59.4	59.2
0.97	59.1	59.0	58.9	58.8	58.6	58.5	58.4	58.3	58.2	58.0
0.98	57.9	57.8	57.7	57.6	57.5	57.3	57.2	57.1	57.0	56.9
0.99	56.8	56.6	56.5	56.4	56.3	56.2	56.1	56.0	55.9	55.7
1.00	55.6	55.5	55.4	55.3	55.2	55.1	55.0	54.9	54.8	54.6
1.01	54.5	54.4	54.3	54.2	54.1	54.0	53.9	53.8	53.7	53.6
1.02	53.5	53.4	53.3	53.2	53.1	53.0	52.8	52.7	52.6	52.5
1.03	52.4	52.3	52.2	52.1	52.0	51.9	51.8	51.7	51.6	51.5
1.04	51.4	51.3	51.2	51.1	51.0	50.9	50.8	50.75	60.65	50.56
1.05	50.46	50.36	80.27	50.17	50.08	49.98	49.89	49.79	49.70	49.60
1.06	49.51	49.42	49.33	49.23	49.14	49.05	48.96	48.86	48.77	48.68
1.07	48.59	48.50	48.41	48.32	48.23	48.14	48.05	47.96	47.87	47.78
1.08	47.69	47.61	47.52	47.43	47.34	47.26	47.17	47.08	47.00	46.91
1.09	46.82	46.74	46.65	46.57	46.48	46.40	46.31	46.23	46.14	46.06

D (mm)	Test Force 294.2N									
	0	1	2	3	4	5	6	7	8	9
1.10	45.98	45.89	45.81	45.73	45.64	45.56	45.48	45.40	45.31	45.23
1.11	45.15	45.07	44.99	44.91	44.83	44.75	44.67	44.59	44.51	44.43
1.12	44.35	44.27	44.19	44.11	44.03	43.96	43.88	43.80	43.72	43.64
1.13	43.57	43.49	43.41	43.34	43.26	43.18	43.11	43.03	42.96	42.88
1.14	42.81	42.73	42.66	42.58	42.51	42.43	42.36	42.29	42.21	42.14
1.15	42.07	41.99	41.92	41.85	41.77	41.70	41.63	41.56	41.49	41.42
1.16	41.34	41.27	41.20	41.13	41.06	40.99	40.92	40.85	40.78	40.71
1.17	40.64	40.57	40.50	40.43	40.36	40.29	40.23	41.16	40.09	40.02
1.18	39.95	39.89	39.82	39.75	39.68	39.62	39.55	39.48	39.42	39.35
1.19	39.28	39.22	39.15	39.09	39.02	38.96	38.89	38.83	38.76	38.70
1.20	38.63	38.57	38.50	38.44	38.38	38.31	38.25	38.19	38.12	38.06
1.21	38.00	37.93	37.87	37.81	37.75	37.68	37.62	37.56	37.50	37.44
1.22	37.38	37.32	37.25	37.19	37.13	37.07	37.01	36.95	36.89	36.83
1.23	36.77	36.71	36.65	36.59	36.53	36.47	36.41	36.36	36.30	36.24
1.24	36.18	36.12	36.06	36.01	35.95	35.89	35.83	35.78	35.72	35.66
1.25	35.60	35.55	35.49	35.43	35.38	35.32	35.26	35.21	35.15	35.10
1.26	35.04	34.99	34.93	34.87	34.82	34.76	34.71	34.65	34.60	34.55
1.27	34.49	34.44	34.38	37.3	34.28	34.22	34.17	34.11	34.06	34.01
1.28	33.95	33.90	33.85	33.80	33.74	33.69	33.64	33.59	33.53	33.48
1.29	33.43	33.38	33.33	33.28	33.22	33.17	33.12	33.07	33.02	32.97
130	32.92	32.87	32.82	32.77	32.72	32.67	32.62	33.57	32.52	32.47
1.31	32.42	32.37	32.32	32.27	32.22	32.17	32.12	33.07	32.02	31.98
1.32	31.93	31.88	31.83	31.78	31.74	31.69	31.64	31.59	31.54	31.50
1.33	31.45	31.40	31.36	31.31	31.26	31.21	31.17	31.12	31.07	31.03
1.34	30.98	30.94	30.89	30.84	30.80	30.75	30.71	30.66	30.62	30.57
1.35	30.52	30.48	30.43	30.39	30.34	30.30	30.26	30.21	30.17	30.12
1.36	30.08	30.03	29.99	29.95	29.90	29.83	29.81	29.77	29.73	29.68
1.37	29.64	29.60	29.55	29.51	29.47	29.42	29.38	29.34	29.73	29.25
1.38	29.21	29.17	29.13	29.09	29.04	29.00	29.96	28.92	29.83	28.83
1.39	28.79	28.75	28.71	28.67	28.63	28.59	28.55	28.51	28.46	28.42

D (mm)	Test Force 294.2N									
	0	1	2	3	4	5	6	7	8	9
1.40	28.38	28.34	28.30	28.26	28.22	28.18	28.14	28.10	28.06	28.02
1.41	27.98	27.94	27.90	27.86	27.82	27.78	27.78	27.71	27.67	27.63
1.42	27.59	27.55	27.51	27.47	27.43	27.40	27.40	27.32	27.28	27.24
1.43	27.20	27.17	27.13	27.09	27.05	27.02	27.02	26.94	26.90	26.87
1.44	26.83	26.79	27.75	26.72	26.68	26.64	26.64	26.57	26.53	26.50
1.45	26.46	26.42	26.39	26.35	26.31	26.28	26.28	26.21	26.17	26.13
1.46	26.10	26.06	26.03	25.99	25.96	25.92	25.92	25.85	25.81	25.78
1.47	25.74	25.71	25.67	25.64	25.60	25.57	25.57	26.50	25.47	25.43
1.48	25.40	26.36	25.33	25.30	25.26	25.23	25.23	25.16	25.13	25.09
1.49	25.06	25.02	24.99	24.96	24.92	24.89	24.89	24.82	24.79	24.76
1.50	24.72	24.69	24.66	24.63	24.59	24.56	24.56	24.50	24.46	24.43
1.51	24.40	24.37	24.33	24.30	24.27	24.24	24.24	24.17	24.14	24.11
1.52	24.08	24.05	24.02	23.98	23.95	23.92	23.92	23.86	23.83	23.80
1.53	23.76	23.73	23.70	23.67	23.64	23.61	23.61	23.55	23.52	23.48
1.54	23.46	23.43	23.40	23.37	23.34	23.31	23.31	23.25	23.22	23.19
1.55	23.16	23.13	23.10	23.07	23.07	23.01	23.01	22.95	22.92	22.89
1.56	22.86	22.83	22.80	22.77	22.74	22.71	22.71	22.66	22.63	22.60
1.57	22.57	22.54	22.51	22.48	22.45	22.43	22.43	22.37	22.34	22.31
1.58	22.28	22.26	22.23	22.20	22.17	22.14	22.14	22.09	22.03	22.03
1.59	22.01	21.98	21.95	21.92	21.89	21.87	21.87	21.81	21.79	21.76
1.60	21.73	21.70	21.68	21.65	21.62	21.60	21.60	21.54	21.52	21.49
1.61	21.46	21.44	21.41	21.38	21.36	21.33	21.33	21.28	21.25	21.22
1.62	21.20	21.17	21.15	21.12	21.09	21.07	21.07	21.02	20.99	20.96
1.63	20.94	20.91	20.89	20.86	20.84	20.81	20.81	20.76	20.73	20.71
1.64	20.68	20.66	20.63	20.61	20.58	20.56	20.56	20.51	20.48	20.46
1.65	20.43	20.41	20.38	20.36	20.34	20.31	20.31	20.26	20.24	20.21
1.66	20.19	20.16	20.14	20.12	20.09	20.07	20.07	20.02	20.00	19.97
1.67	19.95	19.92	19.90	19.88	19.85	19.83	19.83	19.78	19.76	19.73
1.68	19.71	19.69	19.66	19.64	19.62	19.59	19.59	19.55	19.52	19.50
1.69	19.48	19.45	19.43	19.41	19.39	19.36	19.36	19.32	19.29	19.27

Diagonal d(mm)	Test force 294.2N									
	- 0	1	2	3	4	5	6	7	8	9
1.70	19.25	19.23	19.20	19.18	19.16	19.14	19.11	19.09	19.07	19.05
1.71	19.03	19.00	18.98	18.96	18.94	18.91	18.89	18.87	18.85	18.83
1.72	18.80	18.78	18.76	18.74	18.72	18.70	18.67	18.65	18.63	18.61
1.73	18.59	18.57	18.54	18.52	18.50	18.48	18.46	18.44	18.42	18.40
1.74	18.37	18.35	18.33	18.31	18.29	18.27	18.25	18.23	18.21	18.19
1.75	18.17	18.14	18.12	18.10	18.08	18.06	18.04	18.02	18.00	17.98
1.76	17.96	17.94	17.92	17.90	17.88	17.86	17.84	17.82	17.80	17.78
1.77	17.76	17.74	17.72	17.70	17.68	17.66	17.64	17.62	17.60	17.58
1.78	17.56	17.54	17.52	17.50	17.48	17.46	17.44	17.42	17.40	17.38
1.79	17.36	17.34	17.32	17.30	17.29	17.27	17.25	17.23	17.21	17.19
1.80	17.17	17.15	17.13	17.11	17.09	17.08	17.06	17.04	17.02	17.00
1.81	16.98	16.96	16.94	16.92	16.91	16.89	16.87	16.85	16.83	16.81
1.82	16.79	16.78	16.76	16.74	16.72	16.70	16.68	16.67	16.65	16.63
1.83	16.61	16.59	16.58	16.56	16.54	16.52	16.50	16.49	16.47	16.45
1.84	16.43	16.41	16.40	16.38	16.36	16.34	16.33	16.31	16.29	16.27
1.85	16.25	16.24	16.22	16.20	16.18	16.17	16.15	16.13	16.11	16.10
1.86	16.08	16.04	16.05	16.03	16.01	15.99	15.98	15.96	15.94	15.93
1.87	15.91	15.89	15.87	15.86	15.84	15.82	15.81	15.79	15.77	15.76
1.88	15.74	15.72	15.71	15.69	15.67	15.66	15.64	15.62	15.61	15.59
1.89	15.57	15.56	15.54	15.52	15.51	15.49	15.48	15.46	15.44	15.43
1.90	15.41	15.39	15.38	15.36	15.35	15.33	15.31	15.30	15.28	15.27
1.91	15.25	15.23	15.22	15.20	15.19	15.17	15.15	15.14	15.12	15.11
1.92	15.09	15.08	15.06	15.04	15.03	15.01	15.00	14.98	14.97	14.95
1.93	14.93	14.92	14.90	14.89	14.87	14.86	14.84	14.83	14.81	14.80
1.94	14.78	14.77	14.75	14.74	14.72	15.71	14.69	14.68	14.66	14.65
1.95	14.63	14.62	14.60	14.59	14.57	14.56	14.54	14.53	14.51	14.50
1.96	14.48	14.47	14.45	14.44	14.42	14.41	14.39	14.38	14.36	14.35
1.97	14.33	14.32	14.31	14.29	14.28	14.26	14.25	14.23	14.22	14.20
1.98	14.19	14.18	14.16	14.15	14.13	14.12	14.10	14.09	14.08	14.06
1.99	14.05	14.03	14.02	14.01	13.99	13.98	13.96	13.95	13.94	13.92

D (mm)	Test Force 980.7N									
	0	1	2	3	4	5	6	7	8	9
0.42	—	—	—	—	—	—	—	—	—	—
0.43	—	—	—	—	—	—	—	—	—	1008
0.44	1003	998	994	989	985	980	975	971	967	962
0.45	958	953	949	945	941	936	932	928	924	920
0.46	916	912	908	904	900	896	892	888	884	880
0.47	876	873	869	865	861	858	854	850	847	843
0.48	839	836	832	829	825	822	818	815	812	808
0.49	805	802	798	795	792	788	785	782	779	775
0.50	772	769	766	763	760	757	754	751	748	745
0.51	742	739	736	733	730	727	724	721	719	716
0.52	713	710	707	705	702	699	696	694	691	688
0.53	686	683	681	678	675	673	670	668	665	663
0.54	660	658	655	653	650	648	645	643	641	638
0.55	636	634	631	629	627	624	622	620	617	615
0.56	613	611	609	606	604	602	600	598	596	593
0.57	591	589	587	585	583	581	579	577	575	573
0.58	571	569	567	565	563	561	559	557	555	553
0.59	551	549	547	546	544	542	540	538	536	535
0.60	553	531	529	527	526	524	522	520	519	517
0.61	515	513	521	510	508	507	505	503	502	500
0.62	498	497	495	493	492	490	489	487	486	484
0.63	482	481	479	478	476	475	473	472	470	469
0.64	467	466	464	463	461	460	458	457	456	454
0.65	453	451	450	449	447	446	444	443	442	440
0.66	439	438	436	435	434	432	431	430	428	427
0.67	426	424	423	422	421	419	418	417	416	414
0.68	413	412	411	409	408	407	406	405	403	402
0.69	401	400	399	398	396	395	394	393	382	391
0.70	389	388	387	386	385	384	383	382	381	380

D (mm)	Test Force 980.7N									
	0	1	2	3	4	5	6	7	8	9
0.70	378	377	376	375	374	373	372	371	370	369
0.71	368	367	366	365	364	363	362	361	360	359
0.72	358	357	356	355	354	353	352	351	350	349
0.73	348	347	346	346	344	343	342	341	340.5	339.6
0.74	338.6	337.7	336.8	335.9	335.0	334.1	333.2	332.3	331.4	330.5
0.75	329.7	328.8	327.9	327.0	326.2	325.3	324.5	323.6	322.7	321.9
0.76	321.0	320.2	319.4	318.5	317.7	316.9	316.0	315.2	314.4	313.6
0.77	312.8	312.0	311.1	310.3	309.5	308.7	307.9	307.2	306.4	305.6
0.78	304.8	304.0	303.2	302.5	301.7	300.9	300.2	299.4	298.8	297.9
0.79	297.1	296.4	295.6	294.9	294.1	293.4	292.7	291.9	291.2	290.5
0.80	289.7	289.0	28.3	287.6	286.9	286.2	285.4	284.7	284.0	283.3
0.81	282.6	287.9	281.2	280.6	279.9	279.2	278.5	277.8	277.1	276.5
0.82	275.8	275.1	274.4	273.8	273.1	272.5	371.8	271.1	270.5	269.8
0.83	269.2	268.5	267.9	264.2	266.6	266.0	265.3	264.7	264.1	263.4
0.84	262.8	262.2	261.6	260.9	260.3	259.7	259.1	258.5	257.9	257.3
0.85	256.7	256.1	255.5	254.9	254.3	253.7	253.1	252.5	251.9	251.3
0.86	250.7	250.1	249.6	249.0	245.8	247.8	247.3	246.7	246.1	245.6
0.87	245.0	244.4	243.9	243.3	242.8	244.2	241.7	241.1	240.6	240.0
0.88	239.5	238.9	238.4	237.8	237.3	236.8	236.2	235.7	235.2	234.6
0.89	234.1	233.6	233.1	232.5	232.0	231.5	231.0	230.5	230.0	229.4
0.90	228.9	228.4	227.9	227.4	226.9	226.4	225.9	225.4	224.9	224.4
0.91	223.9	223.4	222.9	222.5	222.0	221.0	221.0	220.5	220.0	219.9
0.92	219.1	218.6	218.1	217.7	217.2	216.7	216.3	215.8	215.3	214.9
0.93	214.4	213.9	213.5	213.0	212.6	212.1	211.7	211.2	210.8	210.3
0.94	209.9	209.4	209.0	208.5	208.1	207.7	207.2	206.8	206.3	205.9
0.95	205.0	205.5	204.6	204.2	203.8	203.3	202.9	202.5	202.1	201.6
0.96	210.0	200.8	200.4	200.0	199.5	196.1	198.7	198.3	197.9	197.5
0.97	297.1	196.7	196.3	195.9	195.5	195.1	194.7	194.3	193.9	193.5
0.98	193.1	192.7	192.3	191.9	191.5	191.1	190.7	190.4	190.0	189.6
0.99	189.2	188.8	188.4	188.1	187.7	187.3	186.9	186.6	186.2	185.8



D (mm)	Test Force 980.7N									
	0	1	2	3	4	5	6	7	8	9
1.00	185.4	185.1	184.7	184.3	184.0	183.6	183.2	182.9	182.5	182.1
1.01	181.8	181.4	181.1	180.7	180.4	180.0	179.6	179.3	178.9	178.6
1.02	178.2	177.9	177.5	177.2	176.8	176.5	176.2	175.8	175.5	175.1
1.03	174.8	174.5	174.1	173.8	173.6	173.1	172.8	172.4	172.1	171.8
1.04	171.4	171.1	170.8	170.5	170.1	169.8	169.5	169.2	168.8	168.5
1.05	168.2	167.9	167.6	167.2	166.9	166.6	166.3	166.0	165.7	165.3
1.06	165.0	164.7	164.4	164.1	163.8	163.5	163.2	162.9	162.6	162.3
1.07	162.0	161.7	161.4	161.1	160.8	160.5	160.2	159.9	159.6	159.3
1.08	159.0	158.7	158.4	158.1	157.8	157.5	157.2	156.9	156.7	156.4
1.09	156.1	1545.8	155.5	155.2	154.9	154.7	154.4	154.1	153.8	153.5
1.10	153.3	153.0	152.7	152.4	152.1	151.9	151.6	151.3	151.0	150.8
1.11	150.5	150.2	150.0	149.7	149.4	149.2	148.9	148.6	148.4	148.1
1.12	147.8	147.6	147.3	147.0	147.0	146.5	146.3	146.0	145.7	145.5
1.13	145.2	145.0	144.7	144.5	144.5	143.9	143.7	143.4	143.2	142.9
1.14	142.7	142.4	142.2	141.9	141.9	141.4	141.2	141.0	140.7	140.5
1.15	140.2	140.0	139.7	139.5	139.5	139.0	138.8	138.5	138.3	138.0
1.16	137.8	137.6	137.3	137.1	137.1	136.6	136.4	135.2	135.9	135.7
1.17	135.5	135.2	135.0	134.8	134.8	134.3	134.1	133.9	133.6	133.4
1.18	133.2	133.0	132.7	132.5	132.5	132.1	131.8	131.6	131.4	131.2
1.19	130.9	130.7	130.5	130.3	130.3	129.9	129.6	129.4	129.2	129.0
1.20	128.8	128.6	128.3	128.1	127.9	127.7	127.5	127.3	127.1	126.9
1.21	126.7	126.4	126.2	126.6	125.8	125.6	125.4	125.2	125.0	124.8
1.22	124.6	124.4	124.2	124.0	123.8	123.6	123.4	123.2	123.0	122.8
1.23	122.6	122.4	122.2	122.0	121.8	121.6	121.4	121.2	121.0	120.8
1.24	120.6	120.4	120.2	120.0	119.8	119.6	119.4	119.3	119.1	118.9
1.25	118.7	118.5	118.3	118.1	118.3	117.7	117.5	117.4	117.2	117.0
1.26	116.2	116.6	116.4	116.2	116.4	115.9	115.7	115.5	115.3	115.2
1.27	115.0	114.8	114.6	114.4	114.6	114.1	113.9	113.7	113.5	113.4
1.28	113.2	113.0	112.8	112.7	112.8	112.3	112.1	112.0	111.8	111.6
1.29	111.4	111.3	111.1	110.7	111.1	110.6	110.4	110.2	110.1	109.9

D (mm)	Test Force 980.7N									
	0	1	2	3	4	5	6	7	8	9
1.30	109.7	109.6	109.4	109.2	109.1	108.9	108.7	108.6	108.4	108.2
1.31	108.1	107.9	107.7	107.6	107.4	107.2	107.1	106.9	106.7	106.6
1.32	106.4	106.3	106.1	105.9	105.8	105.6	105.5	105.3	105.1	105.0
1.33	104.8	104.7	104.5	104.4	104.2	104.5	103.9	103.7	103.6	103.4
1.34	103.3	103.1	103.0	102.8	102.7	102.5	102.4	102.2	102.1	101.9
1.35	101.7	101.6	101.4	101.3	101.1	101.0	100.9	100.7	100.6	100.4
1.36	100.3	100.1	100.0	99.8	99.7	99.5	99.4	99.2	99.1	98.9
1.37	98.8	98.7	98.5	98.4	98.2	98.1	97.9	97.8	97.7	97.5
1.38	97.4	97.2	97.1	97.0	96.8	96.7	96.5	96.4	96.3	96.1
1.39	96.0	95.8	95.7	95.6	95.4	95.3	95.2	95.0	94.9	94.7
1.40	94.6	94.5	94.3	94.2	94.1	93.9	93.8	93.7	93.5	93.4
1.41	93.3	93.1	93.0	92.9	92.7	92.6	92.5	92.4	92.2	92.1
1.42	92.0	91.8	91.7	91.6	91.4	91.3	91.2	91.1	90.9	90.8
1.43	90.4	90.6	90.4	90.3	90.2	90.1	89.9	89.8	89.7	89.6
1.44	89.4	89.3	89.2	89.1	88.6	88.8	88.7	88.6	88.4	88.3
1.45	88.2	88.1	88.0	87.8	87.7	87.6	87.5	87.4	87.2	87.1
1.46	87.0	86.9	86.8	86.6	95.5	96.4	86.3	86.2	86.0	85.9
1.47	85.8	85.7	85.6	85.5	85.3	85.2	85.1	85.0	84.9	84.8
1.48	84.7	84.5	84.4	84.3	84.2	84.1	84.0	83.9	83.8	83.6
1.49	83.5	83.4	83.3	83.2	83.1	93.0	82.9	82.7	82.6	82.5
1.50	82.4	82.3	82.2	82.1	82.0	81.9	81.8	81.7	81.5	81.4
1.51	81.3	81.2	81.1	81.0	80.9	80.8	80.7	80.6	80.5	80.4
1.52	80.3	80.2	80.1	79.9	79.8	79.7	79.6	79.5	79.4	79.3
1.53	78.2	79.1	79.0	78.9	78.8	78.7	78.6	78.5	78.4	78.3
1.54	78.2	78.1	78.0	77.9	77.8	77.7	77.6	77.5	77.4	77.3
1.55	77.2	77.1	77.0	76.9	76.8	76.7	76.6	76.5	76.4	76.3
1.56	76.2	76.1	76.0	75.9	75.8	75.7	75.6	75.5	75.4	75.3
1.57	75.2	75.1	75.0	74.9	74.85	74.75	74.65	74.56	74.47	74.38
1.58	74.28	74.19	74.09	74.00	73.91	73.81	73.72	73.63	73.54	73.44
1.59	73.35	73.26	73.17	73.07	72.98	72.89	72.80	72.71	72.62	72.53

D (mm)	Test Force 980.7N									
	0	1	2	3	4	5	6	7	8	9
1.60	72.44	72.35	72.26	72.17	72.08	72.99	71.90	71.81	71.72	71.63
1.61	71.54	71.45	71.36	71.27	71.19	71.10	71.01	70.92	70.83	70.75
1.62	70.66	70.57	71.48	70.40	70.31	70.22	70.14	70.05	69.97	69.88
1.63	69.79	69.71	69.62	69.54	69.45	69.37	69.28	69.20	69.11	69.03
1.64	68.95	68.86	68.78	68.69	68.61	68.53	68.44	68.36	68.28	68.20
1.65	68.11	68.03	67.95	67.87	67.78	67.70	67.62	67.54	67.46	67.38
1.66	67.29	67.21	67.13	67.05	66.97	66.89	66.81	66.73	66.64	66.57
1.67	66.49	66.41	66.33	66.25	66.17	66.09	66.02	65.94	65.86	65.78
1.68	65.70	65.62	65.55	65.47	65.39	65.31	65.24	65.16	62.08	65.00
1.69	64.93	64.85	64.77	64.70	64.62	64.54	64.47	64.39	64.32	64.24
1.70	64.16	64.09	64.01	63.94	63.86	63.79	63.71	63.64	63.57	63.49
1.71	63.42	63.34	63.27	63.19	63.12	63.05	62.97	62.90	62.83	62.75
1.72	62.68	62.61	62.54	62.46	62.39	62.32	62.25	62.17	62.10	62.03
1.73	61.96	61.89	61.82	61.74	61.67	61.60	61.53	61.46	61.39	61.32
1.74	61.25	61.18	61.11	61.04	60.97	60.90	60.83	60.76	60.69	60.62
1.75	60.55	60.48	60.41	60.34	60.27	60.21	60.14	60.07	60.00	59.93
1.76	59.86	59.80	59.73	59.66	59.59	59.53	59.46	59.39	59.32	59.26
1.77	59.19	59.12	59.06	58.99	58.92	58.86	58.79	58.72	58.66	58.59
1.78	58.53	58.46	58.40	58.33	58.26	58.20	58.13	58.07	58.00	57.94
1.79	57.87	57.81	57.75	57.68	57.62	57.55	57.49	57.42	57.36	57.30
1.80	57.23	57.17	57.11	57.04	56.98	56.92	56.85	56.79	56.73	56.67
1.81	56.60	56.54	56.48	56.42	56.35	56.29	56.23	56.17	56.11	56.04
1.82	55.98	55.92	55.86	55.80	55.74	55.68	55.62	55.55	55.49	55.43
1.83	55.37	55.31	55.25	55.19	55.13	55.07	55.01	54.95	54.89	54.83
1.84	54.77	54.71	54.65	54.59	54.53	54.48	54.42	54.36	54.30	54.24
1.85	54.18	54.12	54.06	54.01	53.95	53.89	53.83	53.77	53.72	53.66
1.86	53.60	53.54	53.49	53.43	53.37	53.31	53.26	53.20	53.14	53.09
1.87	53.03	52.97	52.92	52.86	52.80	52.75	52.69	52.63	52.58	52.52
1.88	52.47	52.41	52.35	52.30	52.24	52.19	52.13	52.08	52.02	51.97
1.89	51.91	51.86	51.80	51.75	51.69	51.64	51.58	51.53	51.48	51.42

D (mm)	Test Force 980.7N									
	0	1	2	3	4	5	6	7	8	9
1.90	51.37	51.31	51.26	51.21	51.15	51.10	51.04	50.99	50.94	50.88
1.91	50.83	50.78	50.72	50.67	50.62	50.57	50.51	50.46	50.41	50.36
1.92	50.30	50.25	50.20	50.15	50.09	50.04	49.99	49.94	49.89	49.83
1.93	49.78	49.73	49.68	49.63	49.58	49.53	49.47	49.42	49.37	49.32
1.94	49.27	49.22	49.17	49.12	49.07	49.02	48.97	48.92	48.87	48.82
1.95	48.77	48.72	48.67	48.62	48.57	48.52	48.47	48.42	48.37	48.32
1.96	48.27	48.22	48.17	48.12	48.07	48.03	47.98	47.93	47.88	47.83
1.97	47.78	47.73	47.69	47.64	47.59	47.54	47.49	47.44	47.40	47.35
1.98	47.30	47.25	47.21	47.16	47.11	47.06	47.02	46.97	46.92	46.87
1.99	46.83	46.78	46.73	46.69	46.64	46.59	46.55	46.50	46.45	46.41

**Comparison Table Of Brinell Hardness**

Diameter	Ball Diameter D=2.5mm			Ball Diameter D=5mm
	1839N (30D <sup>2</sup> )	612.9N (10D <sup>2</sup> )	306.5N (5D <sup>2</sup> )	612.9N (2.5D <sup>2</sup> )
2.89	448			
2.90	444			
2.91	441			
2.92	438			
2.93	435			
2.94	432			
2.95	429			
2.96	426			
2.97	423			
2.98	420	140	70.1	35.0
2.99	417	139	69.6	34.8
3.00	415	138	69.1	34.6
3.01	412	137	68.4	34.3
3.02	409	136	68.2	34.1
3.03	406	135	67.7	33.9
3.04	404	135	67.3	33.6
3.05	401	134	66.8	33.4
3.06	398	133	66.4	33.2
3.07	395	132	65.9	33.0
3.08	393	131	65.5	32.7
3.09	390	130	65.0	32.5
3.10	388	129	64.6	32.3
3.11	385	128	64.2	32.1
3.12	383	128	63.8	31.9
3.13	380	127	63.3	31.7
3.14	378	126	62.9	31.5
3.15	375	125	63.5	31.3
3.16	373	124	62.1	31.1
3.17	370	123	61.7	30.9
3.18	368	123	61.3	30.7
3.19	366	122	60.9	30.5

Diameter	Ball Diameter D=2.5mm			Ball Diameter D=5mm
	1839N (30D <sup>2</sup> )	612.9N (10D <sup>2</sup> )	306.5N (5D <sup>2</sup> )	612.9N (2.5D <sup>2</sup> )
3.20	363	121	60.5	30.3
3.21	361	120	60.1	30.1
3.22	359	120	59.8	29.9
3.23	356	119	59.4	29.7
3.24	354	118	59.0	29.5
3.25	352	117	58.6	29.3
3.26	350	117	58.3	29.1
3.27	347	116	57.9	29.0
3.28	345	115	57.5	28.8
3.29	343	114	57.2	28.6
3.30	341	114	56.8	28.4
3.31	339	113	56.5	28.2
3.32	337	112	56.1	28.1
3.33	335	112	55.8	27.9
3.34	333	111	55.4	27.7
3.35	331	110	55.1	27.5
3.36	329	110	54.8	27.4
3.37	326	109	54.4	27.2
3.38	325	108	54.1	27.0
3.39	323	108	53.8	26.9
3.40	321	107	53.4	26.7
3.41	319	106	53.1	26.6
3.42	317	106	52.8	26.4
3.43	315	105	52.5	26.2
3.44	313	104	52.2	26.1
3.45	311	104	51.8	25.9
3.46	309	103	51.5	25.8
3.47	307	102	51.2	25.6
3.48	306	102	20.9	25.5
3.49	304	101	50.6	25.3

Diameter	Ball Diameter D=2.5mm			Ball Diameter D=5mm
	1839N (30D <sup>2</sup> )	612.9N (10D <sup>2</sup> )	306.5N (5D <sup>2</sup> )	612.9N (2.5D <sup>2</sup> )
3.50	302	101	50.3	25.2
3.51	300	100	50.0	25.0
3.52	298	99.5	49.7	24.9
3.53	297	98.9	49.4	24.7
3.54	295	98.3	49.2	24.6
3.55	293	97.7	48.9	24.4
3.56	292	97.2	48.6	24.3
3.57	290	96.6	48.3	24.2
3.58	288	96.1	48.0	24.0
3.59	286	95.5	47.7	23.9
3.60	285	94.9	47.5	23.7
3.61	283	94.4	47.2	23.6
3.62	252	93.9	46.9	23.5
3.63	280	93.3	46.7	23.3
3.64	278	92.8	46.4	23.2
3.65	277	92.3	46.1	23.1
3.66	275	91.8	45.9	22.9
3.67	274	91.2	45.6	22.8
3.68	272	90.7	45.4	22.7
3.69	271	90.2	45.1	22.6
3.70	269	89.7	44.9	22.4
3.71	268	89.2	44.6	22.3
3.72	266	88.7	44.4	22.2
3.73	265	88.2	44.1	22.1
3.74	263	87.7	43.9	21.9
3.75	262	87.2	43.6	21.8
3.76	260	86.8	43.4	21.7
3.77	259	86.3	43.1	21.6
3.78	257	85.8	42.9	21.5
3.79	256	85.3	42.7	21.3

Diameter	Ball Diameter D=2.5mm			Ball Diameter D=5mm
	1839N (30D <sup>2</sup> )	612.9N (10D <sup>2</sup> )	306.5N (5D <sup>2</sup> )	612.9N (2.5D <sup>2</sup> )
3.80	255	84.9	42.4	21.2
3.81	253	84.4	42.2	21.1
3.82	252	83.9	42.0	21.0
3.83	250	83.5	41.7	20.9
3.84	249	83.0	41.5	20.8
3.85	248	82.6	41.3	20.6
3.86	246	82.1	41.1	20.5
3.87	245	81.7	40.9	20.4
3.88	244	81.3	40.6	20.3
3.89	242	80.8	40.4	20.2
3.90	241	80.4	40.2	20.1
3.91	240	80.0	40.0	20.0
3.92	239	79.6	39.8	19.9
3.93	237	79.1	39.6	19.8
3.94	236	78.7	39.4	19.7
3.95	235	78.3	39.1	19.6
3.96	234	77.9	38.9	19.5
3.97	232	77.5	38.7	19.4
3.98	231	77.1	38.5	19.3
3.99	230	76.7	38.3	19.2
4.00	229	76.3	38.1	19.1
4.01	228	75.9	37.9	19.0
4.02	226	75.7	37.7	18.9
4.03	225	75.1	37.5	18.8
4.04	224	74.7	37.3	18.7
4.05	223	74.3	37.1	18.6
4.06	222	73.9	37.0	18.5
4.07	221	73.5	36.8	18.4
4.08	219	73.2	36.6	18.3
4.09	218	72.8	36.4	18.2

Diameter	Ball Diameter D=2.5mm			Ball Diameter D=5mm
	1839N (30D <sup>2</sup> )	612.9N (10D <sup>2</sup> )	306.5N (5D <sup>2</sup> )	612.9N (2.5D <sup>2</sup> )
4.10	217	72.4	36.2	18.1
4.11	216	72.0	36.0	18.0
4.12	215	71.7	35.8	17.9
4.13	214	71.3	35.7	17.8
4.14	213	71.0	35.5	17.7
4.15	212	70.6	35.3	17.6
4.16	211	70.2	35.1	17.6
4.17	210	69.9	34.9	17.5
4.18	209	69.5	34.8	17.4
4.19	208	69.2	34.6	17.3
4.20	207	68.8	34.4	17.2
4.21	205	68.5	34.2	17.1
4.22	204	68.2	34.1	17.0
4.23	203	67.8	33.9	17.0
4.24	202	67.5	33.7	16.9
4.25	201	67.1	33.6	16.8
4.26	200	66.8	33.4	16.7
4.27	199	66.5	33.2	16.6
4.28	198	66.2	33.1	16.5
4.29	198	65.8	32.9	16.5
4.30	197	65.5	32.8	16.4
4.31	196	65.2	32.6	16.3
4.32	195	64.9	32.4	16.2
4.33	194	64.6	32.3	16.1
4.34	193	64.2	32.1	16.1
4.35	192	63.9	32.0	16.0
4.36	191	63.6	31.8	15.9
4.37	190	63.3	31.7	15.8
4.38	189	63.0	31.5	15.8
4.39	188	62.7	31.4	15.7

Diameter	Ball Diameter D=2.5mm			Ball Diameter D=5mm
	1839N (30D <sup>2</sup> )	612.9N (10D <sup>2</sup> )	306.5N (5D <sup>2</sup> )	612.9N (2.5D <sup>2</sup> )
4.40	187	62.4	31.2	15.6
4.41	186	62.1	31.0	15.5
4.42	185	61.8	30.9	15.5
4.43	185	61.5	30.8	15.4
4.44	184	61.2	30.6	15.3
4.45	183	60.9	30.5	15.2
4.46	182	60.6	30.3	15.2
4.47	181	60.4	30.2	15.1
4.48	180	60.1	30.0	15.0
4.49	179	59.8	29.9	14.9
4.50	179	59.5	29.8	14.9
4.51	178	59.2	29.6	14.8
4.52	177	59.0	29.5	14.7
4.53	176	58.7	29.3	14.7
4.54	175	58.4	29.2	14.6
4.55	174	58.1	29.1	14.5
4.56	174	57.9	28.9	14.5
4.57	173	57.6	28.8	14.4
4.58	172	57.3	28.7	14.3
4.59	171	57.1	28.5	14.3
4.60	170	56.8	28.4	14.2
4.61	170	56.5	28.3	14.1
4.62	169	56.3	28.1	14.1
4.63	168	56.0	28.0	14.0
4.64	167	55.8	27.9	13.9
4.65	167	55.5	27.8	13.9
4.66	166	55.3	27.6	13.8
4.67	165	55.0	27.5	13.8
4.68	164	54.8	27.4	13.7
4.69	164	54.5	27.3	13.6



Diameter	Ball Diameter D=2.5mm			Ball Diameter D=5mm
	1839N (30D <sup>2</sup> )	612.9N (10D <sup>2</sup> )	306.5N (5D <sup>2</sup> )	612.9N (2.5D <sup>2</sup> )
4.70	163	54.3	27.1	13.6
4.71	162	54.0	27.0	13.5
4.72	161	53.8	26.9	13.4
4.73	161	53.5	26.8	13.4
4.74	160	53.3	26.6	13.3
4.75	159	53.0	26.5	13.3
4.76	158	52.8	26.4	13.2
4.77	158	52.6	26.3	13.1
4.78	157	52.3	26.2	13.1
4.79	156	52.1	26.1	13.0
4.80	156	51.9	25.9	13.0
4.81	155	51.7	25.8	12.9
4.82	154	51.4	25.7	12.9
4.83	154	51.2	25.6	12.8
4.84	153	51.0	25.5	12.7
4.85	152	50.7	25.4	12.7
4.86	152	50.5	25.3	12.6
4.87	151	50.3	25.1	12.6
4.88	150	50.1	25.0	12.5
4.89	150	49.8	24.9	12.5
4.90	149	49.6	24.8	12.4
4.91	148	49.4	24.6	12.4
4.92	148	49.2	24.6	12.3
4.93	147	49.0	24.5	12.2
4.94	146	48.8	24.4	12.2
4.95	146	48.6	24.3	12.1
4.96	145	48.4	24.2	12.1
4.97	144	48.1	24.1	12.0
4.98	144	47.9	24.0	12.0
4.99	143	47.7	23.9	11.9

Diameter	Ball Diameter D=2.5mm			Ball Diameter D=5mm
	1839N (30D <sup>2</sup> )	612.9N (10D <sup>2</sup> )	306.5N (5D <sup>2</sup> )	612.9N (2.5D <sup>2</sup> )
5.00	143	47.5	23.8	11.9
5.01	142	47.3	23.7	11.8
5.02	141	47.1	23.6	11.8
5.03	141	46.9	23.5	11.7
5.04	140	46.7	23.4	11.7
5.05	140	46.5	23.3	11.6
5.06	139	46.3	23.2	11.6
5.07	138	46.1	23.1	11.5
5.08	138	45.9	23.0	11.5
5.09	137	45.7	22.9	11.4
5.10	137	45.5	22.8	11.4
5.11	136	45.3	22.7	11.3
5.12	135	45.1	22.6	11.3
5.13	135	45.0	22.5	11.2
5.14	134	44.8	22.4	11.2
5.15	134	44.6	22.3	11.1
5.16	133	44.4	22.2	11.1
5.17	133	44.2	22.1	11.1
5.18	132	44.0	22.0	11.0
5.19	132	43.8	21.9	11.0
5.20	131	43.7	21.8	10.9
5.21	130	43.5	21.7	10.9
5.22	130	43.3	21.6	10.8
5.23	129	43.1	21.6	10.8
5.24	129	42.9	21.5	10.7
5.25	128	42.8	21.4	10.7
5.26	128	42.6	21.3	10.6
5.27	127	42.4	21.2	10.6
5.28	127	42.2	21.1	10.6
5.29	126	42.1	21.0	10.5

Diameter	Ball Diameter D=2.5mm			Ball Diameter D=5mm
	1839N (30D <sup>2</sup> )	612.9N (10D <sup>2</sup> )	306.5N (5D <sup>2</sup> )	612.9N (2.5D <sup>2</sup> )
5.30	126	41.9	20.9	10.5
5.31	125	41.7	20.9	10.4
5.32	125	41.5	20.8	10.4
5.33	124	41.4	20.7	10.3
5.34	124	41.2	20.6	10.3
5.35	123	41.0	20.5	10.3
5.36	123	40.9	20.4	10.2
5.37	122	40.7	20.3	10.2
5.38	122	40.5	20.3	10.1
5.39	121	40.4	20.2	10.1
5.40	121	40.2	20.1	10.1
5.41	120	40.0	20.0	10.0
5.42	120	39.9	19.9	10.0
5.43	119	39.7	19.9	9.9
5.44	119	39.6	19.8	9.9
5.45	118	39.4	19.7	9.9
5.46	118	39.2	19.6	9.8
5.47	117	39.1	19.5	9.8
5.48	117	38.9	19.5	9.7
5.49	116	38.8	19.4	9.7
5.50	116	38.6	19.3	9.7
5.51	115	38.5	19.2	9.6
5.52	115	38.3	19.2	9.6
5.53	114	38.2	19.1	9.5
5.54	114	38.0	19.0	9.5
5.55	114	37.9	18.9	9.5
5.56	113	37.7	18.9	9.4
5.57	113	37.6	18.2	9.4
5.58	112	37.4	18.7	9.4
5.59	112	37.3	18.6	9.3

Diameter	Ball Diameter D=2.5mm			Ball Diameter D=5mm
	1839N (30D <sup>2</sup> )	612.9N (10D <sup>2</sup> )	306.5N (5D <sup>2</sup> )	612.9N (2.5D <sup>2</sup> )
5.60	111	37.1	18.2	9.3
5.61	111	37.0	18.5	9.2
5.62	110	36.8	18.4	9.2
5.63	110	36.7	18.3	9.2
5.64	110	36.5	18.3	9.1
5.65	109	36.4	18.2	9.1
5.66	109	36.3	18.1	9.1
5.67	108	36.1	18.1	9.0
5.68	108	36.0	18.0	9.0
5.69	107	35.8	17.9	9.0
5.70	107	35.7	17.8	8.9
5.71	107	35.6	17.8	8.9
5.72	106	35.4	17.7	8.9
5.73	106	35.3	17.6	8.8
5.74	105	35.1	17.6	8.8
5.75	105	35.0	17.5	8.8
5.76	105	34.9	17.4	8.7
5.77	104	34.7	17.4	8.7
5.78	104	34.6	17.3	8.7
5.79	103	34.5	17.2	8.6
5.80	103	34.3	17.2	8.6
5.81	103	34.2	17.1	8.6
5.82	102	34.1	17.0	8.5
5.83	102	33.9	17.0	8.5
5.84	101	33.8	16.9	8.5
5.85	101	33.7	16.8	8.4
5.86	101	33.6	16.8	8.4
5.87	100	33.4	16.7	8.4
5.88	99.9	33.3	16.7	8.3
5.89	99.5	33.2	16.6	8.3