



www.insize.com

INSIZE



**ISE-2DT
DIGITAL LEVEL
OPERATION MANUAL**



Introduction

Thanks for buying our product. ISE-2DT is a high precision dual axis level with a color LCD and touch panel. It is possible to do high speed horizontal plane setting for high precision machines or home appliance as like laundry machine.

1 Specialty:

- ◆ Easy to set the level of the space with 2 axis angles display at once.
- ◆ Level up the visual-effects by the color LCD.
- ◆ Small & light so that possible to use to a sensor unit.
- ◆ Possible to insert to high precision systems.
- ◆ Built-in Li-ion rechargeable battery. (Rechargeable to USB port on PC)
- ◆ Set the tolerance and the display is shown in different colors.

2 Structure:

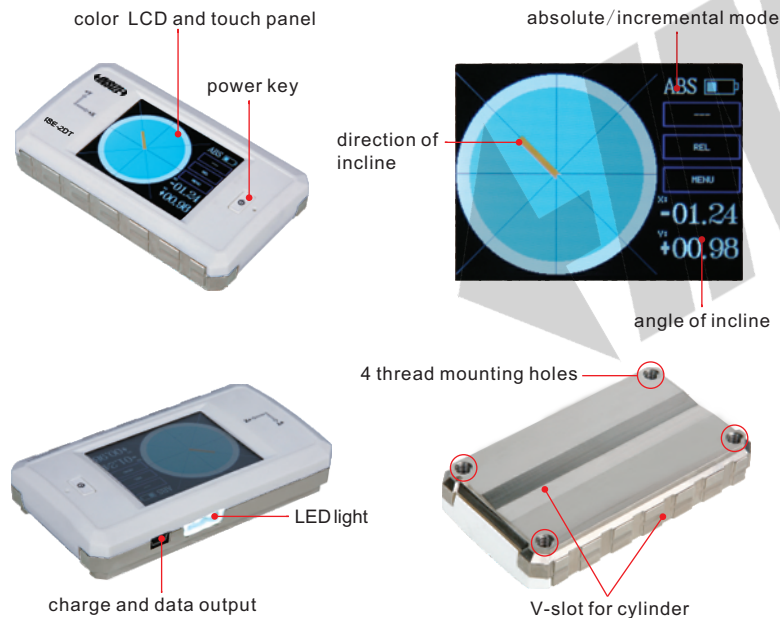

Power Key And Touch Panel

1 Power key has 4 functions below.

- ◆ Power on: Pushing the key once if power is off then the power is on with a sound.
- ◆ Power off: Pushing the key for around 2 sec when the power is on. Then the power is off.
- ◆ Flash on/off: Pushing the key for under 1 sec after power is on. Then the flash is on / off. The touch panel is not worked when the flash is on.
- ◆ Touch panel calibration: Pushing the key for over 5 sec. Then it is in the calibration mode of touch panel.
 - This function is used when the touch panel doesn't work well.
 - The power should be on to enter this calibration mode.

2 Touch panel : There are 3 sections on the touch panel that have their own function. The below functions are exceeded if each sections are touched.

Note: You must keep touching action until reach the change .

- ◆ Main menu entrance: To enter the main menu, touch the 'MENU' area.
- ◆ Absolute/Incremental mode change area : To change the X/Y to absolute or incremental mode. (ABS↔REL)
 - Absolute mode: The displayed values of X/Y are from the absolute coordinate system. The absolute coordinate system is set from the factory or user's updating at the calibration menu.
 - Incremental mode: To make current X/Y values to zero.
- ◆ Tilt direction display area: To change the tilted direction display method. (line↔bubble)

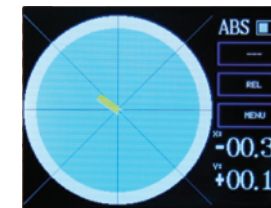

line

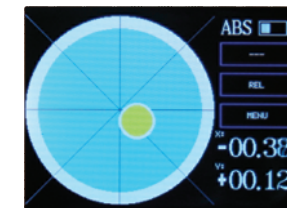

bubble

Main Menu

The main menu is composed as the following picture. Each functions can be chosen by touching the letters.

MENU (Ver 1.0)	
Run	Mode: POLE
Spec	Calibration
Average	Display
Serial	Save
About	

① Run: To exit the main menu and display the measuring screen.

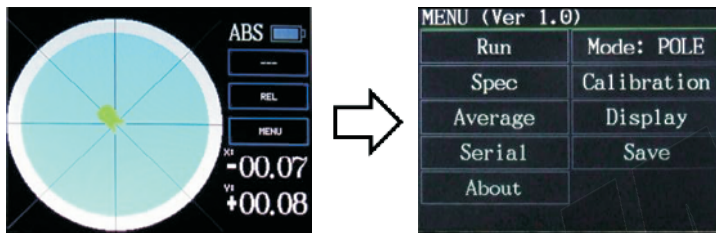

② Mode: To change the mode of display.

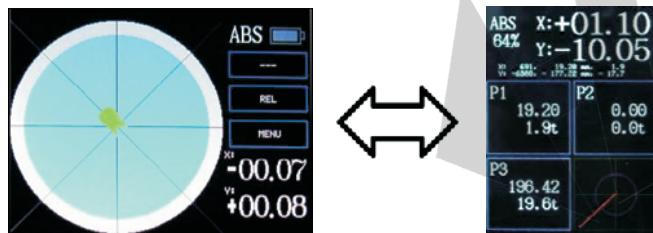

*** The composition of the screen for Flat mode (to adjusting 4 legs machines)**

Absolute value / Relative value To change ABS & REL, touch this area.	ABS 64% X: +01.10 Y: -10.05	X/Y angle [°] / To enter the main menu, touch this area.
Battery remains	P1 19.20 1.9t	P2 0.00 0.0t
The height to adjust	P3 196.42 19.6t	The adjusting points display area. -The heights of the each points are already calculated depends on the tilted angles. So users can adjust the horizontal plane faster and easier.
The amount to turn the adjusting screw legs		The direction of tilted space

③ Spec: To setup the spec. for the FLAT mode.

Spec	
Go Back	Tolerance
Model: 0	X: 1000 mm
Y: 1000 mm	Pitch: 10 mm
Angle: 360	

- ◆ Go Back: To exit the 'Spec' menu.
- ◆ Tolerance: To setup the tolerance of the tilted direction display line, the green line or bubble means within the tolerance.
- ◆ Model: 10 memory spaces are given to save the users' specification setting. And user could recall them later.
- ◆ X: The width of the setting points.
- ◆ Y: The length of the setting points.
- ◆ Pitch: The pitch of the screwed legs at the home appliances or other machines.
- ◆ Angle: It is set by 360 deg. normally.

④ Calibration: To calibrate the absolute zero. Please follow the steps carefully. If not, it can not be guaranteed the angle data.

- ◆ XY Calibration: Put the level on the surface as following picture and choose the 'XY 1st'. Then you might see 'XY 1st Please Touch Screen'. If the level is settled well on the surface, touch the screen and wait until the level gathers the data and averages them.
Turn the level 180 degrees and choose the 'XY Rev'. And touch the screen if the level is settled.



- ◆ X Calibration: Put the level on the surface as following picture and choose the 'X 1st'. Then you might see 'X 1st Please Touch Screen'. If the level is settled well on the surface, touch the screen.

Turn the level 180 degrees and choose the 'X Rev'. And touch the screen if the level is settled.



- ◆ Default: If the calibration is not done well, user can choose the 'default'. Then level will recall the zero setting values at the factory.
- 5 Average: To change the number of inputting row data to average them. It can be set from 1 to 30.
- 6 Display: To change display options as like brightness, display off time, etc.

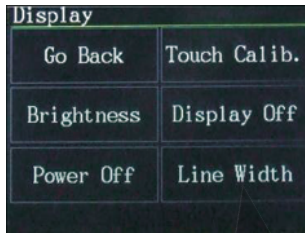

- ◆ Go Back: To exit the 'Display' menu.
- ◆ Touch Calibration: To calibrate the touch panel.
- ◆ Brightness: To change the brightness of the screen.
- ◆ Display Off: To change the display on time. The screen will be off after this time.
- ◆ Power Off: To change the power on time. The power will be off after this time.
- ◆ Line width: To change the width of the tiled direction indicating line at the POLE mode.
- 7 Save: To save whatever user has changed, it should be done. If user doesn't want to save the current changes, just turn off the power.
- 8 About: To see the information of the manufacturer.

Operation

1 Three using method:

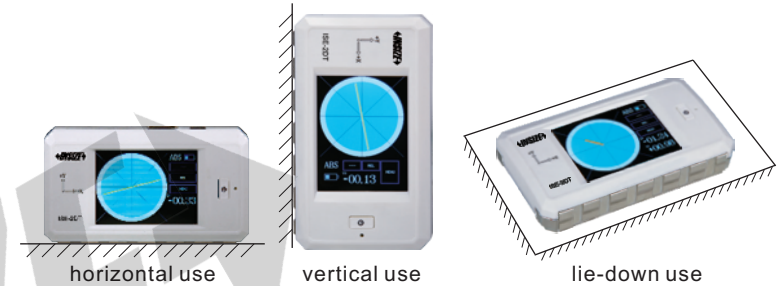

2 Flat mode: Flat mode is used to adjust the 4 legs machines, like laundry machine, etc., very easily. There are shown the 3 points, that makes a plane, with the heights to raise up.

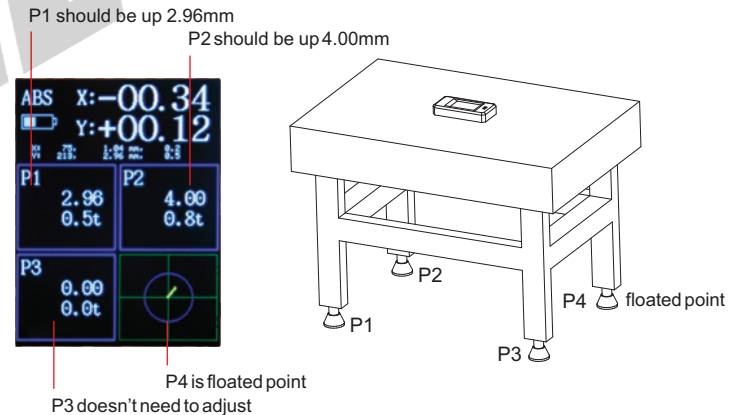

The floated point should be taught by user. It could be P1, P2, P3, or P4 depend on situation. If user touches the area of the floated point on the screen, ISE-2DT calculates and displays the heights of the other 3 points. The floated point should be filled up at the last after user finishes to adjust the 3 points level.

Note:
Before measuring, to use this flat mode, user also has to set the parameters.